

ENGINEERING DATA



Smith &
Loveless, Inc.®

14040 West Santa Fe Trail Drive
Lenexa, Kansas 66215-1284

Large Recessed Wet Well
Mounted Pump Station
2-Pump, 3-Pump &
Series Section Index
May, 2012
Page 1 of 2

LARGE RECESSED WET WELL MOUNTED PUMP STATION 2-PUMP, 3-PUMP & SERIES SECTION INDEX

DESCRIPTION	DATE	PAGE
Design Factors		
• Station Friction Loss	May, 2012	1
2-PUMP STATION		
• 2-Pump Recessed Wet Well Mounted Pump Station – 8” Pumps Specification	May, 2012	1 – 16
3-PUMP STATION		
• 3-Pump Recessed Wet Well Mounted Pump Station Specification	May, 2012	1 – 18
SERIES PUMP STATION		
• Series Recessed Specification	May, 2012	1 – 18
Outline Drawings		
• Series RWWMPS 4B2B / 4B2D / 4C2B / 4C2D Pumps – 4” Piping	87C335	
• Series RWWMPS 4B2B / 4B2D / 4C2B / 4C2D Pumps – 6” Piping	87C336	
• Series RWWMPS 4B3B / 4C3D / 4D3B Pumps – 4” Piping	87C337	
• Series RWWMPS 4B3B / 4C3D / 4D3B Pumps – 6” Piping	87C338	
• Series RWWMPS 6B3_ / 6C3_ / 6D3_ Pumps – 6” Piping	87C339	
• Concrete Anchor Detail – Recessed WWMPS	87B720	
• Installation Details – Vacuum Primed Stations	87B650	

ENGINEERING DATA



Smith &
Loveless, Inc.®

14040 West Santa Fe Trail Drive
Lenexa, Kansas 66215-1284

Large Recessed Wet Well
Mounted Pump Station
2-Pump, 3-Pump &
Series Section Index
May, 2012
Page 2 of 2

Outline Drawings

LARGE 2-PUMP RECESSED WET WELL MOUNTED PUMP STATION

- 2-Pump Recessed Wet Well Mounted Pump Station, 8" Pumps, 8" Piping 87C384
- 2-Pump Recessed Wet Well Mounted Pump Station, 8" Pumps, 10" Piping 87C385
- 2-Pump Recessed Wet Well Mounted Pump Station, 8" Pumps, Large Wet Well Installation, 8C4D / 8D4D Pumps 87C357
- Recessed Wet Well Mounted Pump Station, 8" Pumps, Concrete Anchor Detail 87C360

3-PUMP RECESSED WET WELL MOUNTED PUMP STATION

- 3-Pump Recessed Wet Well Mounted Pump Station, 6" Piping 87B718
- 3-Pump Recessed Wet Well Mounted Pump Station, Large Wet Well Installation 87C361
- Recessed Wet Well Mounted Pump Station, Concrete Anchor Detail 87B720

ENGINEERING DATA



Smith &
Loveless, Inc.®

14040 West Santa Fe Trail Drive
Lenexa, Kansas 66215-1284

Wet Well Mounted
Pump Station
Station Friction Loss
Design Factors
May, 2012
Page 1

STATION FRICTION LOSS DESIGN FACTORS WET WELL MOUNTED PUMP STATION

2-PUMP STATIONS 4" PIPING		2-PUMP OR 3-PUMP STATIONS 6" PIPING				LARGE 2-PUMP STATIONS			
GPM	FEET	GPM	FEET	GPM	FEET	8" PIPING		10" PIPING	
GPM	FEET	GPM	FEET	GPM	FEET	GPM	FEET	GPM	FEET
100	0.5	100	0.1	800	5.5	400	0.6	800	1.0
150	1.2	200	0.3	900	7.0	600	1.2	1000	1.4
200	2.0	300	0.5	1000	8.5	800	2.0	1200	2.0
250	3.2	400	1.5	1100	10.0	1000	3.0	1400	2.5
300	4.5	500	2.3	1200	12.0	1200 (3)	4.2	1600	3.2
350 (1)	6.0	600	3.2			1400	5.6	1800 (4)	4.0
400	7.6	700 (2)	4.3			1600	7.1	2000	5.0
						1800	9.0	2200	6.0
								2400	7.0

1. 350 GPM and above based on 6" suction lines.
2. 700 GPM and above based on 8" suction lines.
3. 1200 GPM and above based on 10" suction lines.
4. 1800 GPM and above based on 12" suction lines.

NOTE: Please refer to Pump Curves for recommended suction and discharge piping sizes.

ENGINEERING DATA



Smith &
Loveless, Inc.®

14040 West Santa Fe Trail Drive
Lenexa, Kansas 66215-1284

2-Pump Recessed Wet Well
Mounted Pump Station
8" Pumps
Specification
May, 2012
Page 1

SPECIFICATION 2-PUMP RECESSED WET WELL MOUNTED PUMP STATION 8" PUMPS

GENERAL

The contractor shall furnish and install one factory-built, automatic pumping station as manufactured by Smith & Loveless, Inc., Lenexa, Kansas. The station shall be complete with all needed equipment, factory-installed in a dual compartment welded steel chamber consisting of a separate entrance to the wet well and an equipment chamber. The equipment chamber shall have a 36" diameter entrance with fiberglass cover.

The principal items of equipment shall include two vertical, close-coupled, motor driven, vacuum primed, non-clog pumps; valves; internal piping; central control panel with circuit breakers; motor starters and automatic pumping level controls; lighting; sump pump; ventilating blower; priming pumps with **SONIC START**® pump prime detection system and appurtenances; and all internal wiring.

OPERATING CONDITIONS

Each pump shall be capable of delivering _____ GPM of raw water or wastewater against a total dynamic head of _____ feet. The maximum allowable speed shall be _____ RPM. The minimum rated horsepower of each pump motor shall be _____. The minimum pump efficiency at the design point shall be ____%. Due to energy conservation requirements, the specified minimum efficiency shall be enforced. The maximum static suction lift shall be _____.

All openings and passages shall be large enough to permit the passage of a sphere 3" in diameter. The anticipated operating head range is from _____ feet minimum to _____ feet maximum. The pump motors shall not be overloaded beyond their nameplate rating, at the design conditions, nor at any head in the operating range.

CONSTRUCTION

The station shall be constructed in one complete factory-built assembly. It shall be sized to rest on the top of the wet well as detailed in the construction drawings. The supporting floor shall be minimum 3/8" thick steel with reinforcing, as required, to prevent deflection and ensure an absolutely rigid support. The head and shell shall be of 1/4" minimum thickness steel plate, with the shell rolled to 9'-8" inside diameter. Steel plate shall meet or exceed ASTM A-36 specifications.

The equipment chamber shall be physically separated from the wet well. Wet well access shall be completely separate from the equipment chamber and shall be provided with the access manway exposed only to the atmosphere.

The equipment chamber shall be provided with a fiberglass cover equipped with a keyed lock that can be easily opened from inside the station. The fiberglass cover shall be formed with a drip lip around the edge. A gravity type lid support shall be provided to lock the lid in the open position and restrain it under load. An aluminum ladder shall be located in the station to provide easy access.

Motor lifting lugs shall be provided above each pump to allow for removal of the pumps. Adequate headroom shall be provided to allow the pump impeller to be raised above the volute for removal.

A steel manway cover located exterior to the pump chamber shall be provided. The manway shall be an integral part of the station head plate and shall provide access into the wet well. The wet well access cover shall be provided with hasp and staple arrangement for padlocking.

ENGINEERING DATA



Smith &
Loveless, Inc.®

14040 West Santa Fe Trail Drive
Lenexa, Kansas 66215-1284

2-Pump Recessed Wet Well
Mounted Pump Station
8" Pumps
Specification
May, 2012
Page 2

□ DURO-LAST® Corrosion-Resistant Stainless Steel Baseplate [Optional Item. Designer Check If Required]

The baseplate of the pump station structure shall be fabricated of corrosion-resistant lean duplex series 2100 stainless steel alloy, 316L stainless steel or equal. The stainless steel shall have a Pitting Resistance Equivalent Number (PRE_N) of 24.0 or greater and general corrosion resistance shall be less than or equal to 0.1 mm per year in 15% H₂SO₄ at 120 degrees F. Due to the corrosion resistance requirements, Grade 304-304L is not acceptable.

The stainless steel surfaces shall be glass bead blast cleaned to remove surface contamination and provide a uniform finish.

The manufacturer of the station shall warrant the stainless steel baseplate for twenty-five (25) years from date of shipment against structural failure and perforation due to corrosion.

WELDING

All steel in the station structure shall be joined by electric arc welding with fillets of adequate section for the joint involved. Where required to exclude groundwater, all welded joints on the exterior of the station shall be continuous throughout their length.

PROTECTION AGAINST CORROSION

All structural steel surfaces shall be factory blasted with steel grit to remove rust, mill scale, weld slag, etc. All weld spatter and surface roughness shall be removed by grinding. Surface preparation shall comply with SSPC-SP6 specifications. Immediately following cleaning, a single 6-mil dry film thickness of **VERSAPOX**® epoxy resin shall be factory applied. This coating shall be as formulated by Smith & Loveless for abrasion and corrosion resistance.

Stainless steel, aluminum and other corrosion resistant surfaces shall not be coated. Carbon steel surfaces not otherwise protected shall be coated with a suitable non-hardening rust preventative compound. Auxiliary components, such as the electrical enclosure, ventilating blower and vacuum pumps, shall be furnished with the original manufacturers coating.

Finish coating shall be accomplished prior to shipment of the station from the factory and shall comply fully with the intent of these specifications. A touchup kit shall be provided by the pump station manufacturer for repair of any mars or scratches occurring during shipping and installation. This kit shall contain detailed instructions for use and shall be the same material as the original coating.

A heavy synthetic rubber mat shall be cemented to the station floor by the Manufacturer to protect the coating on the steel floor.

Two 17-pound magnesium anode packs shall be provided for cathodic protection. The anode packs shall be provided with 30' long insulated copper leads. Copper lugs shall be provided by the Manufacturer on opposite sides of the station for anode connections.

MAIN PUMPS

The pumps shall be 8" vertical, non-clog type of heavy cast-iron construction, especially designed for the use of mechanical seals and vacuum priming. In order to minimize seal wear caused by linear movement of the shaft, the shaft bearing nearest the pump impeller shall be locked in place so that endplay is limited to the clearance within the bearing. To minimize seal wear resulting from shaft deflection caused by the radial thrust of the pump, the shaft from the top of the impeller to the lower bearing supporting the impeller shall have a minimum diameter of 1-7/8" for motor frame sizes 213 through 286; 2-1/8" for motor frame sizes 324 and 326; and 3" for frame 364 and larger. The dimension from the lowest bearing to the top of the impeller shall not exceed 6".

The bearing nearest the impeller shall be designed for the combined thrust and radial load. The upper bearing shall be free to move linearly with the thermal expansion of the shaft and shall carry only radial loads.

The shaft shall be solid stainless steel through the mechanical seal to eliminate corrosion and abrasive rust particles.

ENGINEERING DATA



Smith &
Loveless, Inc.®

14040 West Santa Fe Trail Drive
Lenexa, Kansas 66215-1284

2-Pump Recessed Wet Well
Mounted Pump Station
8" Pumps
Specification
May, 2012
Page 3

Removable shaft sleeves will not be acceptable if the shaft under the sleeve does not meet the specified minimum diameter.

The pump impeller shall be of the enclosed type made of close-grained cast-iron and shall be balanced. The impeller shall be keyed with a stainless steel key and secured to the motor shaft by a stainless steel cap screw equipped with a Nylock or other suitable self-locking device. The impeller shall not be screwed or pinned to the motor pump shaft and shall be readily removable without the use of special tools. To prevent the buildup of stringy materials, grit and other foreign particles around the pump shaft, all impellers less than full diameter shall be trimmed inside the impeller shroud. The shroud shall remain full diameter so that close minimum clearance from shroud to volute is maintained. Both the end of the shaft and the bore of the impeller shall be tapered to permit easy removal of the impeller from the shaft.

The pump shall have an adapter providing a large water reservoir above the impeller to provide for positive exclusion of air from the impeller. The seal shall be inside this area to assure lubrication. Pumps which do not use hollow priming adapters for positive lubrication of the seal will not be acceptable.

The pump shall be constructed so as to permit priming from the low-pressure area behind the impeller. Priming from high-pressure connections tending to cause solids to enter and clog the priming system, will not be acceptable. The priming bowl shall be transparent to enable the operator to monitor the priming level.

The pump shall be arranged so that the rotating element can easily be removed from the volute without disconnecting the electrical wiring or disassembling the motor, impeller, backhead or seal, so that any foreign object may be removed from the pump or suction line.

The pump shaft shall be sealed against leakage by a single mechanical seal constructed so as to be automatically drained and primed each time the pump is drained and primed. Water which lubricates the mechanical seal shall be automatically drained from around the seal if the pump loses prime, in order to allow both the pump and the seal to be drained, thereby preventing freezing and breakage of the seal during power outages in sub-freezing temperatures.

The seal shall be of carbon and ceramic materials with the mating surfaces lapped to a flatness tolerance of one light band. The rotating ceramic shall be held in mating position with the stationary carbon by a stainless steel spring.

MOTORS

The pump motors shall be vertical, solid shaft, NEMA P-base, squirrel-cage induction type, suitable for _____ phase, _____ cycle, _____ volt electric current. They shall have Class F insulation. Insulation temperature shall, however, be limited to Class B. The motors shall have normal starting torque and low-starting current, as specified by NEMA Design B characteristics. They shall be open drip-proof design with forced air circulation by integral fan. Openings for ventilation shall be uniformly spaced around the motor frame. Leads shall be terminated in a cast connection box and shall be clearly identified.

The motors shall have 1.15 service factor. The service factor shall be reserved for the owner's protection. The motors shall not be overloaded beyond their nameplate rating, at the design conditions, nor at any head in the operating range as specified under Operating Conditions.

The motor-pump shaft shall be centered, in relation to the motor base, within .005". The shaft runout shall not exceed .003".

The motor shaft shall equal or exceed the diameter specified under main pumps, at all points from immediately below the top bearing to the top of the impeller hub.

A bearing cap shall be provided to hold the bottom motor bearing in a fixed position. Bearing housings shall be provided with fittings for lubrication as well as purging old lubricant.

ENGINEERING DATA



Smith &
Loveless, Inc.®

14040 West Santa Fe Trail Drive
Lenexa, Kansas 66215-1284

2-Pump Recessed Wet Well
Mounted Pump Station
8" Pumps
Specification
May, 2012
Page 4

The motor shall be fitted with heavy lifting eyes or lugs, each capable of supporting the entire weight of the pump and motor.

[NOTE TO DESIGNER: CHOOSE FROM THE FOLLOWING MOTOR OPTIONS, IF REQUIRED. DELETE IF NOT REQUIRED]

A. SUPER DUTY MOTORS

The pump motors shall be Premium Efficiency type, per NEMA MG-1 table 12-12, Inverter Ready per NEMA Part 31.4.4.2, with cast-iron frames, and be UL Recognized and CSA Approved. The motor windings shall be 200 C Inverter Spike-Resistant magnet wire and the rotors shall have an epoxy coating for corrosion protection.

B. IMMERSIBLE PUMP MOTORS

The pump motors shall be of special construction and fitted with special seals to enable the motor to be immersed in up to 30' of water for a period of up to three weeks, without water entering the motor cavity. As part of the immersible motor package, a float switch shall be provided in the station to provide indication of water approaching the level of the motors and another float switch shall shut down the motors when the water level reaches them. Each of these floats shall signal alarms and activate alarm lights on the control panel. The alarms shall remain activated until manually reset by switches on the panel. In addition, moisture detectors and high temperature thermostats shall be provided in each motor, as a backup, to shut down the associated pump and to signal alarm conditions and activate alarm lights on the control panel. All of these alarm contacts shall be wired to a terminal strip in the control panel for connection to the Owner's alarm system.

CONTROLS

The control equipment shall be mounted in a NEMA Type 1 steel enclosure with a hinged access cover. The circuit breakers and control switches shall be operable without opening the access cover.

A grounding type convenience outlet shall be provided on the side of the cabinet for operation of 120-volt AC devices.

Thermal magnetic air circuit breakers shall be provided for branch disconnect service and short circuit protection of all motor control and auxiliary circuits. Magnetic across-the-line starters with under-voltage release and overload coils for each phase shall be provided for each pump motor to give positive protection. Each single-phase auxiliary motor shall be equipped with an over-current protection device in addition to the branch circuit breaker, or shall be impedance protected. All switches shall be labeled and a coded wiring diagram shall be provided.

(OPTIONAL ITEM – CHECK IF REQUIRED)

SINGLE-PHASE 120-VOLT POWER TRANSFORMER PACKAGE [DESIGNER: SELECT IF SEPARATE 120-VOLT SUPPLY IS NOT AVAILABLE. ALSO SELECT 3, 5 OR 7.5 KVA SIZE]

<u>Suction Pipe Size</u>	<u>Aux. Heater</u>	<u>Min. Transformer Size</u>
4"	No	3 KVA 208/230/460v
4"	No	5 KVA 208/230/460v
6" or 8"	No	5 KVA 208/230/460v
6" or 8"	Yes	7.5 KVA 208/230/460v

A (3) (5) (7.5) KVA insulating-type transformer shall be provided to supply power for lights, controls and auxiliary devices. The transformer shall have 240/480 volt primary, 120/240 volt secondary, Class F insulation, with temperature rise not to exceed 115°C above 40°C ambient. The core and coil assembly shall be given a double dip and bake. The coil shall be protected by a metal housing to prevent damage. The transformer shall be protected by a separate circuit breaker on the supply side.



[NOTE TO DESIGNER: SELECT ONE OF THE FOLLOWING LEVEL CONTROL SYSTEM PARAGRAPHS, A OR B, AND DELETE THE OTHER.]

A. FLOAT SWITCH LEVEL CONTROLS

To control the operation of the pumps with variations of liquid level in the wet well, a minimum of three (3) displacement switches shall be provided. A 30' cord shall be provided with each switch. The cord shall have a corrosion-resistant vinyl jacket and be multi-stranded in order to prevent fatigue.

An automatic alternator with manual switch shall be provided to change the sequence of operation of the pumps every eight hours. Alternating the pumps at less than eight-hour intervals will not be acceptable.

Provisions shall also be made for the pumps to operate in parallel should the level in the wet well continue to rise above the starting level for the low-level pump.

B. PUMLOGIX™ MICROPROCESSOR LEVEL CONTROL SYSTEM

The liquid level in the wet well shall be monitored by a submersible hydrostatic pressure transducer with stainless steel sensor diaphragm, providing a 4-20 mA signal to the pump control unit. The body of the transducer shall be made of 316 stainless steel. The pressure transducer shall have a permanent hermetically sealed connection to a polyethylene insulated cable, which shall support the transducer 6" from the bottom of the wet well, and shall pass through a cord grip seal in the station base. The pressure transducer unit shall be rated for wastewater or potable water service, and for operation in explosion hazardous areas.

Three (3) displacement switches shall be provided to automatically operate the pump in back-up mode, in case of failure of the digital control system or the submersible level transducer. The back-up system shall be entirely independent of the digital system. A 30' color-coded cord shall be provided with each switch. The cord shall have a corrosion-resistant vinyl jacket and be multi-stranded in order to prevent fatigue. The displacement switch cords and the cable for the submersible pressure transducer shall enter the wet well through cord grip seals.

To control the operation of the pumps with variations of liquid level in the wet well, and the high and low water alarm functions, a specially preprogrammed, dedicated microprocessor-based control system shall be provided. The controller shall interface with the wet well level transducer, integral panel display unit, motor starters, and alarm functions as required.

The digital controls shall operate on 24 volts or less, to eliminate shock hazard. The 24-volt power supply shall be overload protected to be "crowbar safe" and will return to operation when a short is removed.

To reduce exposure to corrosive environments and ensure the control system's reliable, long-term operation, the controller shall have a sealed, user-friendly, graphical interface. The interface shall be comprised of a rotary knob, switches and five (5) columns of ultra-bright, daylight-viewable red LED's. Four (4) 40-segment, 4" columns of LED's shall show the wet well level, the pump on and off control bands and the high and low alarm setpoint bands. All LED's within a control band shall be illuminated when operating under normal power. A fifth LED column shall indicate the controller's configuration, status, and active alarms. Alarms shall consist of high alarm, low alarm and input signal out of range. Monitor functions shall include control power and normal system operation. Discrete LED's shall show the activation of the differential pump control stages.

The controller shall provide easy, convenient indication and adjustment of the operating setpoints and controller configuration without the need for tools. For ease of operation and configuration, multiple indicating columns are required. Controllers that provide fewer columns; thus, limiting the viewing of relevant and necessary station information, are specifically precluded by this specification.

The pump control circuits shall be forced OFF by power loss. Upon power restoration, the controller shall enable the pumps in an adjustable time-step sequence as required to meet the demand.

ENGINEERING DATA



Smith &
Loveless, Inc.®

14040 West Santa Fe Trail Drive
Lenexa, Kansas 66215-1284

2-Pump Recessed Wet Well
Mounted Pump Station
8" Pumps
Specification
May, 2012
Page 6

The controller shall continuously indicate the status of the selected alternation sequence and control modes. The controller shall provide 1st On/1st Off, Fixed and Auto Rotate alternation sequences.

Integral span, offset, and damping adjustments shall be easily adjustable. The controller shall have a configurable security lockout feature.

The controller shall contain a level simulation function that allows manual manipulation of the displayed process variable. While simulating, the controller shall display both the actual wet well level and the simulated level.

The controller shall contain an RS-232 communication port and have capabilities for connection to a SCADA (Supervisory Control and Data Acquisition) system using Modbus® protocol. The complete assembly shall be designed for use in UL508 Industrial Control Panels.

It is the specific intention of this functional requirement that a controller shall be provided with features as described herein. Additionally, this controller shall be a fully integrated assembly. That is, the furnishing of similar functions using multiple setpoint modules, a custom-configured programmable logic controller (PLC) or extensive relay/timer logic to accomplish control sequences, etc., is specifically precluded by this specification and is not acceptable.

HIGH WET WELL LEVEL ALARM

An adjustable displacement switch shall be provided to sense a high water level condition. The switch shall hang into the wet well and shall activate a contact to indicate the high water condition.

RUNNING TIME METER

A running time meter shall be supplied for each pump to show the number of hours of operation. The meter shall be enclosed in a dust and moisture-proof molded plastic case. The flush-mounted dial shall register in hours and tenths of hours up to 99,999.9 hours before repeating. The meter shall be suitable for operation from a 115-volt, 60-cycle supply.

PUMP FAILURE TO PRIME OR FAILURE TO PUMP ALARM (CHECK VALVE SWITCH TYPE)

To sense failure to deliver normal flow for any reason, including failure to prime, each pump shall be provided with a sealed sensor switch mounted in a protective ABS enclosure. The enclosure shall be mounted with an adjustable universal mounting bracket to the external arm of each discharge check valve. The mounting bracket shall allow the adjustment of the sensor switch with a single locking pivot adjustment. A red LED indicating light shall be provided on each switch unit to facilitate accurate setting of the switch for proper operation. The sensor switch shall monitor the movement of the check valve arm and thereby detect failure of the pump to deliver normal operating flow when called on to run. An auxiliary time delay relay shall be provided to prevent an alarm signal during the pump priming and startup period.

VACUUM-PRIMING SYSTEM

A vacuum priming system shall be furnished to prime the main pumps. The system shall be as shown on the vacuum priming schematic and shall include two vacuum pumps, providing 100 percent standby. Vacuum pumps shall have corrosion-resistant internal components. The vacuum priming system shall be complete with large port vacuum control solenoid valves, SONIC START® prime level sensor, float-operated check valves to protect the vacuum pumps, and all necessary shut-off valves as shown on the piping schematic. The float-operated check valves shall have a transparent body for visual inspection. All hoses and tubing used in the priming system shall be at least 3/8" nominal diameter.

The solenoid valves used in the vacuum priming system shall be of the high flow, direct acting brass body type, with threaded ports, NBR seals and 300 Series stainless steel plunger, rod, plate and springs. The minimum orifice diameter shall be 5/16". The solenoid valves shall be UL Listed, with Class F coil rating and of suitable voltage and thermal capacity for the application.

Liquid level in the pump priming chamber shall be monitored by a SONIC START® resonant frequency liquid level probe.

ENGINEERING DATA



Smith &
Loveless, Inc.®

14040 West Santa Fe Trail Drive
Lenexa, Kansas 66215-1284

2-Pump Recessed Wet Well
Mounted Pump Station
8" Pumps
Specification
May, 2012
Page 7

The probe shall be equipped with a piezoelectric drive and sensitive circuits to detect frequency shifts when the probe is covered by liquid. The probe shall be completely sealed and have a 316L stainless steel housing for corrosion resistance. It shall be provided with a wiring connector molded of PolyPhenylSulfone, an amorphous high performance thermoplastic for impact and chemical resistance. The probe shall have a plug-in connector to facilitate easy removal.

The **SONIC START**® probe shall be provided with light emitting diodes. This diagnostic tool shall indicate connectivity, prime status or a fault condition. Systems utilizing an electrode, mechanical means such as a float, or that require any type of electrical or moving parts inside the priming chamber, which may accumulate debris, short out, bind or fail will not be acceptable.

The priming system shall automatically provide positive lubrication of the mechanical seal each time a main pump is primed. To prevent excessive stoppage due to grease accumulation, no passageway in the priming system through which the pumped liquid must pass shall be smaller than the equivalent of a 2-1/2" opening.

The vacuum priming system shall have two field selectable modes of operation. In the "On-Demand" mode, the priming system will operate only after a pump is called on to run, and if it is not primed. Once primed, the pump will be allowed to run. In the "Constant Prime" mode, both pumps are kept primed continuously, and ready to start immediately when called for.

LIGHTING

A twin 30-watt fluorescent light fixture and guard shall be mounted opposite the control panel to provide adequate illumination for all areas within the equipment chamber. A manual switch located in the equipment chamber shall be provided to turn the lights and ventilating blower on when the cover is closed.

VENTILATING BLOWER

A ventilating blower shall be provided, capable of delivering (200 cfm) 30 air changes per hour of outside air into the equipment chamber. The blower shall be rigidly mounted to the chamber shell and shall discharge into the station as shown on the plans. It shall be controlled by a percentage timer to provide essentially continuous ventilation.

SUMP PUMP

A submersible sump pump with close-coupled motor shall be installed in the sump. It shall be rated 1000 GPH at design head. A mechanical seal on the shaft shall exclude water from the motor housing. The sump pump shall be controlled automatically by a float switch. It shall discharge into the entryway to the wet well through a steel pipe as shown on the plans.

MAIN PIPING

The pump suction shall be drilled and tapped for a 125 pound American Standard flange for ready connection of the suction riser. The discharge line from each pump shall be fitted with a clapper-type check valve and eccentric plug valve. Size, location and quantity of check valves and plug valves shall be as shown on the plans.

The check valve shall be of the spring-loaded type with external lever arm and an easily replaced resilient seat for added assurance against vacuum leaks. Check valves shall have stainless steel shaft with replaceable bronze shaft bushings and shall be sealed with an adjustable Teflon seal. An operating wrench shall be provided for the plug valves.

Pump suction lines protruding through the floor plate shall be welded tight to effect sealing between the equipment chamber and the wet well.

The pump station manufacturer shall extend the piping connections below the floor plate at the factory, so that field connections can be made without disturbing the gas-tight seals. The manufacturer of the pump station shall provide a compression-type sleeve coupling for installation in the common discharge pipe.

The attached pump specification and checklist must be met in total. There are many reasons for incorporating a good pump specification. For example, the stainless steel shaft with tapered impeller attachment is provided to minimize corrosion, extend

ENGINEERING DATA



Smith &
Loveless, Inc.®

14040 West Santa Fe Trail Drive
Lenexa, Kansas 66215-1284

2-Pump Recessed Wet Well
Mounted Pump Station
8" Pumps
Specification
May, 2012
Page 8

seal life and provide ease of impeller removal and seal replacement without the use of a wheel puller. All items specified are for long life, durability and maintainability of the pumping equipment. Deviations from the pump specifications will not be allowed.

A checklist is also provided to insure that the proper pumping system is provided to the owner.

FACTORY TESTS

All components of the pump station shall be given an operational test at the pump station manufacturer's facility to check for excessive vibration, for leaks in the piping or seals and correct operation of the automatic control and vacuum priming systems and all auxiliary equipment. Installed pumps shall take suction from a deep wet well, simulating actual service conditions.

The control panel shall undergo both a dry logic test and a full operational test with all systems operating. Factory test instrumentation shall include flow measuring with indicator; compound suction gauge; bourdon tube type discharge pressure gauge; electrical meters to measure amperes, volts, kilowatts and power factor; speed indicator and a vibrometer capable of measuring both amplitude and frequency.

SPARE PARTS

A complete replacement pump shaft seal assembly shall be furnished with each pump station. The spare seal shall be packed in a suitable container and shall include complete installation instructions. A spare volute gasket and seal gasket shall be provided.

An instructional video presentation on the pump mechanical seal system in DVD format shall be included. The DVD shall contain a presentation on the following subjects: purpose and location of the mechanical seal, signs of a defective mechanical seal, how to remove the mechanical seal, troubleshooting seal failure causes, seal components, required tools, how to reinstall the seal, and how to place the pump back into service. The video shall include footage of an actual seal replacement.

INSTALLATION AND OPERATING INSTRUCTIONS

Installation of the pump chamber shall be done in accordance with the written instructions provided by the manufacturer.

Operation and maintenance manuals shall be furnished, which cover service procedures for all of the pumping station.

STARTUP

The manufacturer shall provide the services of a factory-trained representative for a maximum period of one (1) day on-site to perform initial startup of the pump station and to instruct the owner's operating personnel in the operation and maintenance of the equipment.

WARRANTY

The manufacturer of the station shall warranty for one (1) year from date of startup, not to exceed eighteen (18) months from date of shipment, that the structure and all equipment he provides will be free from defects in material and workmanship. Warranties and guarantees of the suppliers of various components in lieu of a single source responsibility by the Manufacturer will not be accepted. The Manufacturer shall assume primary responsibility for the warranty of the station and all components.

In the event a component fails to perform as specified or is proven defective in service during the warranty period, the Manufacturer shall repair or replace, at his discretion, such defective part. He shall further provide, without cost, such labor as may be required to replace, repair or modify major components such as the steel structure, main pumps, main pump motors and main piping manifold. After start-up service has been performed, the labor to replace accessory items, such as the blower, priming pumps, alternator, etc., shall be the responsibility of others.

ENGINEERING DATA



Smith &
Loveless, Inc.®

14040 West Santa Fe Trail Drive
Lenexa, Kansas 66215-1284

2-Pump Recessed Wet Well
Mounted Pump Station
8" Pumps
Specification
May, 2012
Page 9

The repair or replacement of those items normally consumed in service, such as seals, grease, light bulbs, etc., shall be considered as part of routine maintenance and upkeep.

It is not intended that the Manufacturer assume responsibility for contingent liabilities or consequential damages of any nature resulting from defects in design, material, workmanship or delays in delivery, replacement or otherwise.

MANUFACTURER'S INSURANCE

All equipment manufacturers, either direct or subcontractors to the general or mechanical contractors, SHALL HAVE in effect at TIME OF BID, CONTRACT AWARD, CONTRACT PERFORMANCE, and WARRANTY TERM, PRODUCT AND COMPREHENSIVE LIABILITY INSURANCE, INCLUDING SUDDEN AND ACCIDENTAL POLLUTION COVERAGE in the amount of FIVE MILLION DOLLARS, \$5,000,000 through an insurance company with a minimum rating of A+ (SUPERIOR) XV according to the BEST'S INSURANCE REPORTS. All policies must be written on an OCCURRENCE BASIS. Policies written on a CLAIMS MADE BASIS are not acceptable. A typical CERTIFICATE OF INSURANCE attesting to the specified coverage issued by the responsible carrier naming the ENGINEER OF RECORD and the OWNER as ADDITIONAL INSURED, must be presented to the named additional insured prior to bid and contract award. A FAILURE TO COMPLY with this requirement BY THE BIDDER will require DISQUALIFICATION of the BID and CONTRACT AWARD.

MANUFACTURED EQUIPMENT

OPTION 1 (STANDARDIZATION) [DELETE THIS LINE FROM FINAL SPEC TEXT]

The specifications and drawings detail Smith & Loveless equipment and represent the minimum standard of quality for both equipment and materials of construction. The contractor shall prepare his bid on the basis of the particular equipment and materials specified for the purpose of determining the low bid.

The owner has standardized on the named equipment in order to optimize their operation, maintenance, and safety programs, provide for interchangeability of costly equipment items, reduce stocking levels required for necessary spare parts and provide increased flexibility in the utilization of their pumping stations. Equipment substitutions, since incompatible with the districts standardizations program, will not be considered.

OPTION 2 (BASE BID WITH BID SUBMITTAL) [DELETE THIS LINE FROM FINAL SPEC]

The specifications and drawings detail Smith & Loveless equipment and represent the minimum standard of quality for both equipment and materials of construction. The contractor shall prepare his bid on the basis of this equipment for the purpose of determining the low bid without consideration of a possible substitute.

Substitution of other makes may be considered if the equipment proposed for substitution is superior or equal in quality and efficiency to the standards of quality named in the specifications and this is demonstrated to the satisfaction of the engineer. Contractors wishing to offer a deduct for substitute equipment shall include the following submittal information with their proposal.

BID SUBMITTAL

This submittal shall include all necessary information for the proper determination of the acceptability of the proposed substitution and shall not necessarily be limited to the following.

- A. Complete description of the equipment, system, process, or function, including a list of system components and features, drawings, catalog information and cuts, manufacturers specifications, including materials description.
- B. Performance data and curves, and horsepower requirements.
- C. Outside utility requirements, such as water, power, air, etc.
- D. Functional description of any internal instrumentation and control supplied including list of parameters monitored, controlled, or alarmed.
- E. Addresses and phone numbers of nearest service centers and a listing of the manufacturers or manufacturers representatives services available at these locations, including addresses and phone numbers of the nearest parts warehouses capable of providing full parts replacement and/or repair services.

ENGINEERING DATA



Smith &
Loveless, Inc.®

14040 West Santa Fe Trail Drive
Lenexa, Kansas 66215-1284

2-Pump Recessed Wet Well
Mounted Pump Station
8" Pumps
Specification
May, 2012
Page 10

- F. A list of five (5) installations in the states where similar equipment by the manufacturer is currently in similar service; include contact name, telephone number, mailing address of the municipality or installation, engineer, owner, and installation contractor; if five installations do not exist, the list shall include all that do exist, if any.
- G. Detailed information on site, architectural, structural, mechanical, plumbing, electrical, and control, and all other changes or modifications to the design and construction work necessary to adapt the equipment or systems to the arrangement shown and/or functions described on the drawings and in the technical specifications. This shall include plan view and section sketches illustrating any additional space requirements necessary to provide the minimum adequate clear space within and around the equipment for operation and maintenance, as shown on the Drawings and specified.
- H. All differences between the specifications and the proposed substitute equipment shall be clearly stated in writing under a heading of "differences".
- I. Other specific submittal requirements listed in the detailed equipment and material specifications.
- J. A completed and signed copy of the "Pump Station Certification Affidavit" which follows.

EVALUATION

Approval of the substitution to bid as an alternate shall in no way relieve the contractor from submitting the specified shop drawings for approval or complying fully with all provisions of the specifications and drawings.

If substituted equipment is accepted, the contractor shall, at his own expense, make any changes in the structures, piping, electrical, etc. necessary to accommodate the equipment. If engineering is required due to substitution of alternate equipment, the contractor shall pay for all engineering charges.

To receive final consideration, copies of the manufacturers quotations for the equipment may be required to document the savings to the satisfaction of the engineer. It is the intent that the owner shall receive the full benefit of the savings in cost of equipment and the contractors bid price shall be reduced by an amount equal to the savings. In all technical and other evaluations, the decision of the engineer is final.

TYPICAL BID FORM

[ADD TO BID FORM AS APPLICABLE TO ABOVE SELECTED OPTION]

OPTION 1

For reasons of standardization, bids shall be based on the named equipment. Alternate bids will not be allowed.

OPTION 2

The bid shall be based on the named equipment. Alternate/substitute equipment may be offered as a deduct, provided all conditions of the "manufactured equipment" section are met.

Alternate/substitute manufacturer _____

Deduct \$ _____

ENGINEERING DATA



Smith &
Loveless, Inc.®

14040 West Santa Fe Trail Drive
Lenexa, Kansas 66215-1284

2-Pump Recessed Wet Well
Mounted Pump Station
8" Pumps
Specification
May, 2012
Page 11

PUMP STATION CERTIFICATION AFFIDAVIT

A submittal will be required to be submitted to the owner by manufacturers proposing alternate, unnamed pump stations with their bid. Included in the submittal shall be full-size drawings and detailed specifications on the proposed pump station. Copies of the engineer's plans and specifications will not be acceptable. Included in the bid submittal shall be the following filled-out checklist. It shall be signed by an officer of the company.

	YES	NO
Close-coupled pump design - no motor to pump shaft coupling		
Pump shaft diameter of _____ minimum through seal		
Full diameter impeller shrouds		
Stainless steel pump shaft with tapered shaft to impeller fit		
Maximum pump shaft overhang of 6"- lower bearing to impeller		
Bronze seal housing		
Minimum pump efficiency at design point of _____ GPM of _____ %		
_____ % pump efficiency at best efficiency point for proposed impeller		
Class F motor insulation with Class B max motor temperature rise and 1.15 service factor		
Motor shaft run-out 0.003" max		
Motor shaft centered to motor base with 0.005"		
Locked lower bearing and floating upper bearing		
One-piece motor adapter/backhead		
Motor HP of _____ at _____ RPM		
Complete pump station factory tested on a wet well		
Priming from low pressure area behind the impeller		
Resonant frequency pump prime detection system		
Transparent priming bowl for operator monitoring		
Hollow priming adapter for positive seal lubrication		
Completely separate priming system for each pump		
Minimum 2-1/2" equivalent opening in priming passageways		
All other items for the station, as specified with minimum sizes, capacities and materials indicated		
Product liability insurance, \$5 million per specification		
Structure blasted with steel grit in environmentally controlled booth prior to coating with epoxy resin		

The consulting engineer shall be the sole judge of whether the proposed equipment is acceptable. The manufacturer shall have the responsibility of submitting sufficient information in one submission. Incomplete or inaccurate submittal data shall be cause for rejection of the proposed equipment.

By an officer of the company signing this affidavit, he has stated 100% compliance with the pump station plans and specifications and further states he will supply or pay for all deficiencies found in the job submittals or after the unit is installed. The consulting engineer shall be the sole judge regarding compliance with the plans and specifications and shall be sole judge on the amount of moneys required if any deficiencies are found. Generally, the amount of money shall be related to, but not limited to, a 20-year station design life.

Signature of Company Officer

Corporate Seal
(Notarized)

Title



ADDITIONAL ACCESSORY OPTIONS [DESIGNER: SELECT AS REQUIRED]

LOW WET WELL LEVEL ALARM

An adjustable displacement switch shall be provided to sense a low water level condition. The switch shall hang into the wet well and shall activate a contact to indicate the low water condition.

RUNNING TIME METER FOR PARALLEL OPERATION

A third running time meter shall be supplied to show the number of hours of operation with both pumps running in parallel. The meter shall be enclosed in a dust and moisture-proof molded plastic case. The flush mounted dial shall register in hours and tenths of hours up to 99,999.9 hours before repeating. The meter shall be suitable for operation from a 115-volt, 60 cycle supply.

PUMP RUNNING LIGHTS

A green panel light to indicate "Pump On" shall be provided for each main pump.

120V ALARM LIGHT

A vapor-proof light fixture with 50-watt lamp for outdoor pole mounting shall be provided with a red globe and guard.

120V ALARM LIGHT WITH FLASHER

A vapor-proof light fixture with 50-watt flashing lamp for outdoor pole mounting shall be provided. The light shall flash during alarm conditions. The fixture shall be complete with a red globe and guard.

120V ALARM BELL

A vibratone-type bell mounted on a weather-tight box suitable for pole mounting shall be provided.

120V ALARM HORN

A vibratone-type horn mounted on a weather-tight box suitable for pole mounting shall be provided.

12V TRICKLE CHARGER

Storage batteries and charger shall be supplied to furnish power for operating alarm annunciators in cases of power failure. The storage batteries (two 3-cell, 6-volt) shall be maintenance-free lead-calcium battery concealed in high impact, heat-resistant and permanently sealed containers. The battery charger shall be solid-state, capable of restoring battery to full charge within 12 hours after a discharge, not exceeding 1.5 hours. Brownout protection is standard, and will activate the unit when AC line voltage drops below 85 volts.

12V ALARM LIGHT

A vapor-proof light fixture with 50-watt lamp for outdoor pole mounting shall be provided with a red globe and guard.

12V ALARM BELL

A vibratone-type bell mounted on a weather-tight box suitable for pole mounting shall be provided.

12V ALARM HORN

A vibratone-type horn mounted on a weather-tight box suitable for pole mounting shall be provided.

PANEL MOUNTED AUTOMATIC RESET ALARM SILENCE SWITCH

A momentary contact alarm-silencing switch mounted on the control panel shall be provided. The alarm shall automatically be reset when the alarm condition is removed.

ENGINEERING DATA



Smith &
Loveless, Inc.®

14040 West Santa Fe Trail Drive
Lenexa, Kansas 66215-1284

2-Pump Recessed Wet Well
Mounted Pump Station
8" Pumps
Specification
May, 2012
Page 13

REMOTE MOUNTED AUTOMATIC RESET ALARM SILENCE SWITCH

A momentary contact alarm-silencing switch mounted in a weatherproof box suitable for pole mounting shall be provided. The alarm shall automatically be reset when the alarm condition is removed.

REMOTE ALARM CONTACTS

In addition to the common, powered local alarm connection, individual unpowered contacts shall be provided and wired to a terminal strip for field connection to a remote alarm monitoring system (not included).

ALARM DIALER INTERFACE (DIALER NOT INCLUDED)

Provisions shall be made within the pump station to facilitate the field installation of an alarm dialer, which is to be furnished and installed by others. The alarm dialer shall be as described elsewhere in these specifications. The factory built pump station shall be provided with a mounting bracket approximately 12 inches by 10-5/8 inches to attach and support the alarm dialer, near the station control panel, beneath the fiberglass enclosure. In addition, openings for conduit connections shall be provided in the bottom of the station control panel and through the side of the station base, to facilitate wiring of the alarm dialer input, output and power connections. In addition to the powered common local alarm contact, the station control panel shall have terminal strip connections for fault-opening alarm contacts to provide discrete alarm input signals to the dialer and shall also include terminal strip connections for a 1/60/120 volt power source, on a separate 15-amp circuit, to power the dialer. Wiring of the dialer shall be done by others during installation of the station in the field.

BASE1-BASE2-AUTO ALTERNATE SELECTOR SWITCH

A 3-position selector switch shall be mounted on the face of the control panel to allow selection of either pump as the lead pump, or to allow for automatic alternation.

SURGE PROTECTIVE DEVICE

A surge protective device for lightning and surge protection with an internal automatic discharge circuit and rated for three-phase service shall be provided.

TIME DELAY

The pump control system shall provide for a time delay to prevent simultaneously starting the pump motors after power failure.

SEQUENTIAL ALTERNATION

In lieu of the timed alternation system, provisions shall be made to alternate the pumps at the completion of each pumping cycle.

GENERATOR INTERLOCK

Provisions shall be made in the control circuit of the lift station to facilitate locking out the standby pump when the emergency generator set is powering the station. An interlock consisting of a normally closed auxiliary contact shall be supplied with the emergency generator controls by the generator manufacturer. This normally closed contact shall be wired to the terminal blocks provided in the lift station control panel by the lift station manufacturer. The interconnecting wiring shall be supplied and connected by the installing contractor.

ADD-A-PHASE INTERFACE

Terminals shall be provided in the lift station control panel to facilitate connection to an external Add-A-Phase phase converter unit.

ROTO PHASE INTERFACE

Terminals and a time delay to prevent simultaneously starting the pump motors after power failure shall be provided in the lift station control panel to facilitate connection to an external Roto Phase phase converter unit.



INTRINSICALLY SAFE CONTROL

Intrinsically safe relays to provide low current isolated switching for the float switches shall be provided.

MAIN CIRCUIT BREAKER

A main circuit breaker shall be installed in the control panel to provide over-current protection for the station, and shall be capable of being used to disconnect the three-phase power to the pump station. The breaker shall be operable without opening the panel, and shall be interlocked with the panel door. It shall be capable of being padlocked in the "Off" position.

SOLID-STATE REDUCED VOLTAGE STARTERS

UL listed, solid-state reduced voltage starters shall be supplied. The starters shall be capable of a soft start and soft stop. The starters shall have built in overload protection as well as built in bypass contactors. One set of form C auxiliary contacts shall be supplied on the starter. The starters shall be powered by 24V DC and shall have a built-in Digital Signal Processor utilizing a low impedance run circuit. The starters shall be easily programmable by using a standard screwdriver.

PHASE MONITOR

A relay with double pole, double throw contacts shall be provided to monitor and protect against phase loss (single-phasing), under voltage (brownouts) and phase reversal (improper sequence). It shall automatically reset when three-phase service returns to normal.

SINGLE-PHASE POWER MONITOR

A single pole, double throw relay shall be provided to monitor the 120v single-phase control power supply and initiate an alarm on loss of power. It shall automatically reset when the single-phase service returns to normal.

PUMP PRIME FAILURE

A time delay relay shall be connected to each vacuum pump. Contacts shall be provided to automatically shut down the operating vacuum pump, allow starting of the next pump in the operating sequence and signal an alarm on excessive vacuum pump operating time. Contacts shall be provided for transmitting an alarm signal.

OPERATOR ASSIST ALARM

The station control panel shall be provided with a maintained contact, manually operated, red mushroom head Operator Assist Alarm Button in an easily accessible position on the control panel to signal emergency operator assistance is required. It also may be used to provide means for testing the alarm system.

UNAUTHORIZED ENTRY ALARM

A timer circuit shall be provided in the control panel to signal unauthorized entry into the pump station. The timer shall be activated whenever the fiberglass cover is opened. A key operated switch shall be provided on the station control panel to provide authorized personnel a means to deactivate the alarm before the timer completes its cycle.

NEMA STARTERS

NEMA rated magnetic across-the-line starters with overload protection for each phase shall be provided for each pump motor to give positive protection against phase unbalance, thermal overload, phase loss and ground fault.

AUXILIARY STATION HEATER

A 1300/1500 watt, dual range, electric heater with automatic circulating fan, thermostat control and an On/Off switch is to be provided. The heater is to be operated by connection to the station convenience receptacle.

INSULATED HOOD

The fiberglass cover shall have a minimum of 1" thick urethane insulation, protected by fiberglass, with an "R" value of 7 or more.

ENGINEERING DATA



Smith &
Loveless, Inc.®

14040 West Santa Fe Trail Drive
Lenexa, Kansas 66215-1284

2-Pump Recessed Wet Well
Mounted Pump Station
8" Pumps
Specification
May, 2012
Page 15

AUTOMATIC LID SWITCH FOR LIGHTS

A switch mounted beneath the station's fiberglass cover shall be actuated when the cover is opened and automatically turn on the station lights and ventilation blower.

CERTIFIED CURVES

Factory certified performance test curves shall be provided for the pumps, tested after installation in the station, to stimulate actual operating conditions. Copies of these curves, showing head, flow, BHP, efficiency, and the back-up data, shall be provided with the station. Typical data or curves from a similar pump are not acceptable. Data and curves must be for the actual pumps provided, and while mounted in the station.

STATION FLOODING ALARM

A float operated switch shall be mounted near the station floor to detect accumulation of liquid above the normal sump pump operating level, and send an alarm signal.

DEHUMIDIFIER

A dehumidifier assembly with hermetically sealed Freon refrigeration-type compressor, expansion coil, fan and condenser coil shall be furnished to maintain the relative humidity of the air in the pump chamber low enough to keep the electrical equipment dry and to prevent condensation on the walls.

The moisture removing capability of the dehumidifier will vary with the temperature and relative humidity within the station. The minimum capacity rating at 80° F and 68% relative humidity shall be 15.5 pints per day. The maximum capacity of 80° F and 90% relative humidity shall be 25 pints per day. The dehumidifier shall be controlled automatically by an adjustable humidistat. The dehumidifier shall be located on the station floor and the condensate drained to the sump.

MANWAY LADDER

An aluminum ladder shall be provided in the manway portion of the station, to facilitate access.

MANWAY LADDER SAFETY DEVICE

A 36" extendable bar shall be fitted to the manway ladder, to provide easier entry, when raised.

ADDITIONAL ANODES

___ Additional magnesium anodes (for a total of ___) shall be provided with the station for cathodic protection.

WET WELL BLOWER

A ventilating blower capable of delivering 100 CFM shall be provided for ventilation of the wet well. The wet well blower shall be enclosed in a NEMA 3R rain-tight cabinet with a louvered cover and shall be mounted on the station base adjacent to the manway access hatch. A manual switch on the control panel shall operate the blower.

PROTECTED LIQUID FILLED COMPOUND PRESSURE GAUGES

A four-inch (4") Bourdon tube type compound vacuum/pressure gauge with 3-1/2" dial, fitted with a brass stop valve and a manual air relief valve shall be provided for each pump. The gauges shall be mounted apart from the pumps, on a bracket attached to the control panel support structure, and connected to the pump discharge taps by flexible tubing, to minimize vibration. The range of each gauge shall be selected to place the normal operating discharge pressure reading in the middle one-third of the scale and the gauge shall also be capable of measuring up to 30" HG of vacuum. The dial shall be white with black markings and the gauge itself shall have an accuracy of 1% of scale. The gauge shall be American made, with a Zytel Nylon case with 1/2" blowout plug, stainless steel bezel, acrylic lens and phosphorus bronze tube with brass socket. Each compound gauge shall be filled with a viscous fluid to dampen vibration and pulsation effects on the needle reading. Temperature compensation shall be provided by an internal compensating diaphragm. Gauges shall be protected from the service fluid by a Buna-N elastomer "boot" diaphragm within the stem, and the Bourdon tube and the space between the Bourdon tube and the internal isolating diaphragm shall be filled with low temperature instrument oil, completely isolating the gauge components from the fluid being measured.

ENGINEERING DATA



Smith &
Loveless, Inc.®

14040 West Santa Fe Trail Drive
Lenexa, Kansas 66215-1284

2-Pump Recessed Wet Well
Mounted Pump Station
8" Pumps
Specification
May, 2012
Page 16

EMERGENCY PUMPING CONNECTION

The common discharge pipe of the pump station shall be fitted with a branch with a plug valve and male quick-connect fitting with cap, as shown on the drawings, to facilitate connection of a portable emergency pump to the force main, to bypass the pump station. The emergency pumping connection shall be housed within the fiberglass cover.

TOOLKIT

A metal toolbox complete with the following tools shall be provided. This complement of tools shall include all tools necessary to replace the pump mechanical seal.

9/16" x 1/2" Box End Wrench
3/4" x 5/8" Open End Wrench
15/16" x 1" Open End Wrench
1-1/8" Socket
8" T-Handle 11" x 1/2" Drive
1/2" x 5-1/2" Drive Extension
6" Pipe Wrench
#3 Rawhide Mallet
Ratchet-Type Hoist
Motor Lifting Bar
Lint-Free Cloth
Multi-Purpose Grease

ADDITIONAL SPARE MECHANICAL SEALS

In addition to the one standard spare mechanical seal, ____ additional spare mechanical seal(s) shall be provided. The spare seal(s) shall be packed in a suitable container and shall include complete installation instructions.

TEST UNIT WITH BATTERY FOR MULTI-SENSOR CHECK VALVE SWITCH [FOR USE WITH RELAY LOGIC CONTROLS. NOT REQUIRED WITH PROTRONIX® II OR PUMPLIGIX™ CONTROLLERS]

To test or set the multi-Sensor check valve switches, using the built-in LED light, with Relay Logic control systems, a separate, hand held, battery pack, with connecting cord and plug, shall be provided. This is to enable the operator to accurately set the trip point of the switch manually, by means of the built-in test light on the Multi-Sensor.

ENGINEERING DATA



Smith &
Loveless, Inc.®

14040 West Santa Fe Trail Drive
Lenexa, Kansas 66215-1284

3-Pump Recessed Wet Well
Mounted Pump Station
Specification
May, 2012
Page 1

SPECIFICATION 3-PUMP RECESSED WET WELL MOUNTED PUMP STATION

GENERAL

The contractor shall furnish and install one factory-built, automatic pumping station as manufactured by Smith & Loveless, Inc., Lenexa, Kansas. The station shall be complete with all needed equipment, factory-installed in a dual compartment welded steel chamber consisting of a separate 36" diameter entrance to the wet well and an equipment chamber. The equipment chamber shall have a two-piece, hinged fiberglass cover.

The principal items of equipment shall include three vertical, close-coupled, motor driven, vacuum primed non-clog pumps; valves; internal piping; central control panel with circuit breakers; motor starters and automatic pumping level controls; lighting; sump pump; ventilating blower; priming pumps with **SONIC START**® pump prime detection system and appurtenances; and all internal wiring.

OPERATING CONDITIONS

Each pump shall be capable of delivering _____ GPM of raw water or wastewater against a total dynamic head of _____ feet. The minimum acceptable pump efficiency at this condition shall be ____%. Due to the energy conservation requirements, the minimum efficiency will be enforced. The maximum allowable speed shall be _____ RPM. The minimum rated horsepower of each pump motor shall be _____. The maximum static suction lift shall be _____.

Two pumps operating in parallel shall deliver a combined capacity of _____ GPM at _____ TDH.

Two pumps operating in parallel shall meet the design conditions of the station with the third pumping unit acting as standby.

All openings and passages shall be large enough to permit the passage of sphere 3" in diameter. The anticipated operating head range is from _____ feet minimum to _____ feet maximum. The pump motors shall not be overloaded beyond their nameplate rating, at the design conditions, nor at any head in the operating range.

CONSTRUCTION

The station shall be constructed in one complete factory-built assembly. It shall be sized to rest on the top of the wet well as detailed in the construction drawings. The supporting floor shall be minimum 3/8" thick steel reinforced as required to prevent deflection and ensure an absolutely rigid support. The head and shell shall be of 1/4" minimum thickness steel plate, with the shell rolled to 9'-10" inside diameter. Steel plate shall meet or exceed ASTM A-36 specifications.

The equipment chamber shall be physically separated from the wet well. Wet well access shall be completely separate from the equipment chamber and shall be provided with the access manway exposed only to the atmosphere.

The equipment chamber shall be provided with two separate hinged fiberglass covers. The fiberglass covers shall be formed with a drip lip around the edges. Brackets shall be provided to support the covers in the open position and to restrain them under load. An aluminum ladder with safety extension pole shall be located in the station to provide easy access. Only one segment of the fiberglass cover need be opened for personnel access into the equipment chamber, but either or both may be opened for equipment access. A single cover will not be acceptable.

Motor lifting lugs shall be provided above each pump to allow for removal of the pumps. Adequate headroom shall be provided to allow the pump impeller to be raised above the volute for removal.

A 36" diameter steel manway access to the wet well, with hinged and lockable fiberglass cover, located exterior to the pump chamber shall be provided. The manway shall be an integral part of the station and shall provide access into the wet well.

ENGINEERING DATA



Smith &
Loveless, Inc.®

14040 West Santa Fe Trail Drive
Lenexa, Kansas 66215-1284

3-Pump Recessed Wet Well
Mounted Pump Station
Specification
May, 2012
Page 2

□ DURO-LAST® Corrosion-Resistant Stainless Steel Baseplate [Optional Item. Designer Check If Required]

The baseplate of the pump station structure shall be fabricated of corrosion-resistant lean duplex series 2100 stainless steel alloy, 316L stainless steel or equal. The stainless steel shall have a Pitting Resistance Equivalent Number (PRE_N) of 24.0 or greater and general corrosion resistance shall be less than or equal to 0.1 mm per year in 15% H₂SO₄ at 120 degrees F. Due to the corrosion resistance requirements, Grade 304-304L is not acceptable.

The stainless steel surfaces shall be glass bead blast cleaned to remove surface contamination and provide a uniform finish.

The manufacturer of the station shall warrant the stainless steel baseplate for twenty-five (25) years from date of shipment against structural failure and perforation due to corrosion.

WELDING

All steel in the station structure shall be joined by electric arc welding with fillets of adequate section for the joint involved. Where required to exclude groundwater, all welded joints on the exterior of the station shall be continuous throughout their length.

PROTECTION AGAINST CORROSION

All structural steel surfaces shall be factory blasted with steel grit to remove rust, mill scale, weld slag, etc. All weld spatter and surface roughness shall be removed by grinding. Surface preparation shall comply with SSPC-SP6 specifications. Immediately following cleaning, a single 6-mil dry film thickness of **VERSAPOX**® epoxy resin shall be factory applied. This coating shall be as formulated by Smith & Loveless for abrasion and corrosion resistance.

Stainless steel, aluminum and other corrosion-resistant surfaces shall not be coated. Carbon steel surfaces not otherwise protected shall be coated with a suitable non-hardening rust preventative compound. Auxiliary components, such as the electrical enclosure, ventilating blower and vacuum pumps shall be furnished with the original manufacturer's coating.

Finish coating shall be accomplished prior to shipment of the station from the factory and shall comply fully with the intent of these specifications. A touchup kit shall be provided by the pump station manufacturer for repair of any marks or scratches occurring during shipping and installation. This kit shall contain detailed instructions for use and shall be the same material as the original coating.

A heavy synthetic rubber mat shall be cemented to the station floor by the Manufacturer to protect the coating on the steel floor.

Two 17-pound magnesium anode packs shall be provided for cathodic protection. The anode packs shall be provided with 30' long insulated copper leads. Copper lugs shall be provided by the Manufacturer on opposite sides of the station for anode connections.

MAIN PUMPS

The pumps shall be (4") (6") (8") vertical, centrifugal non-clog type of heavy cast-iron construction, especially designed for the use of mechanical seals and vacuum priming. In order to minimize seal wear caused by linear movement of the shaft, the shaft bearing nearest the pump impeller shall be locked in place so that end play is limited to the clearance within the bearing. To minimize seal wear resulting from shaft deflection caused by the radial thrust of the pump, the shaft from the top of the impeller to the lower bearing supporting the impeller shall have a minimum diameter of 1-7/8" for motor frame sizes 213 through 286; 2-1/8" for motor frame sizes 324 and 326; and 3" for frame 364 and larger. The dimension from the lowest bearing to the top of the impeller shall not exceed 6".

The oversized shaft incorporating oversized bearings and heavier bearing frame construction provides for extended mechanical seal, bearing and overall pump/motor life. Since the larger shaft with the specified minimum overhang is the key to heavier, more rigid construction throughout, no deviation from the specified shaft diameter or tolerances will be allowed.

ENGINEERING DATA



Smith &
Loveless, Inc.®

14040 West Santa Fe Trail Drive
Lenexa, Kansas 66215-1284

3-Pump Recessed Wet Well
Mounted Pump Station
Specification
May, 2012
Page 3

The bearing nearest the impeller shall be designed for the combined thrust and radial load. The upper bearing shall be free to move in a linear direction with the thermal expansion of the shaft and shall carry only radial loads.

The shaft shall be solid stainless steel through the mechanical seal to eliminate corrosion and abrasive rust particles. Removable shaft sleeves will not be acceptable if the shaft under the sleeve does not meet the specified minimum diameter.

The pump shall have an adapter providing a large water reservoir above the impeller to provide for positive exclusion of air from the impeller. The seal shall be inside this area to assure lubrication. Pumps which do not use hollow priming adapters for positive lubrication of the seal will not be acceptable.

The pump shall be constructed so as to permit priming from the lower pressure area behind the impeller. Priming from high-pressure connections, which tends to cause solids to enter and clog the priming system, will not be acceptable. The priming bowl shall be transparent, enabling the operator to monitor the priming level.

The pump shall be arranged so that the rotating element can easily be removed from the casing without disconnecting the electrical wiring or disassembling the motor, impeller, backhead or seal, so that any foreign object may be removed from the pump or suction line.

The pump shaft shall be sealed against leakage by a single mechanical seal constructed so as to be automatically drained and primed each time the pump is drained and primed. Water which lubricates the mechanical seal shall be automatically drained from around the seal if the pump loses prime in order to allow both the pump and the seal to be drained, thereby preventing freezing and breakage of the seal during power outages in sub-freezing temperatures.

The seal shall be of carbon and ceramic materials with the mating surfaces lapped to a flatness tolerance of one light band. The rotating ceramic shall be held in mating position with the stationary carbon by a stainless steel spring. The entire seal assembly shall be held in place by a bronze seal housing to prevent excessive heat buildup. Use of cast-iron or other ferrous material for the seal housing which will rust and damage the seal, shortening its life, will not be acceptable.

The pump volute shall be furnished with mounting lugs and bolted to the station floor plate, forming a gas-tight seal.

[NOTE TO DESIGNER: SELECT ONE OF THE FOLLOWING PUMP TYPE PARAGRAPHS, A OR B, AND DELETE THE OTHER. CHECK PUMP CURVES FOR PROPER APPLICATION]

A. NON-CLOG TWO-PORT IMPELLER (4", 6", 8" PUMP OPTION)

The pump impeller shall be of the enclosed two-port type made of close-grained cast-iron and shall be balanced. The eye of the impeller as well as the ports shall be large enough to permit the passage of a sphere 3" in diameter in accordance with nationally recognized codes. The impeller shall be keyed with a stainless steel key and secured to the motor shaft by a stainless steel capscrew equipped with a Nylock or other suitable self-locking device. The impeller shall not be screwed or pinned to the motor pump shaft and shall be readily removable without the use of special tools. To prevent the buildup of stringy materials, grit and other foreign particles around the pump shaft, all impellers less than full diameter shall be trimmed inside the impeller shrouds. The shrouds shall remain full diameter so that close minimum clearance from shrouds to volute is maintained. Both the end of the shaft and the bore of the impeller shall be tapered to permit easy removal of the impeller from the shaft.

B. X-PELLER® SUPER CLOG-RESISTANT MONO-PORT IMPELLER (4" & 6" PUMP OPTION)

The pump impeller shall be of the enclosed mono-port type made of close-grained cast-iron and shall be in dynamic balance when pumping wastewater. Two port impellers are specifically disallowed. The dynamic balance shall be obtained without the use of balance weights or liquid filled chambers. The impeller shall be designed to allow for the trimming of the impeller to meet design condition changes without altering the balance. The eye of the impeller as well as the port shall be large enough to

ENGINEERING DATA



Smith &
Loveless, Inc.®

14040 West Santa Fe Trail Drive
Lenexa, Kansas 66215-1284

3-Pump Recessed Wet Well
Mounted Pump Station
Specification
May, 2012
Page 4

permit the passage of a sphere 3" in diameter in accordance with nationally recognized codes. To further prevent clogging, the impeller port shall have a minimum area of 10.6 in². The impeller shall be keyed with a stainless steel key and secured to the motor shaft by a stainless steel capscrew equipped with a Nylock or other suitable self-locking device. The impeller shall not be screwed or pinned to the motor pump shaft and shall be readily removable without the use of special tools. To prevent the buildup of stringy materials, grit and other foreign particles around the pump shaft, all impellers less than full diameter shall be trimmed inside the impeller shrouds. The shrouds shall remain full diameter so that close minimum clearance from shrouds to volute is maintained. Both the end of the shaft and the bore of the impeller shall be tapered to permit easy removal of the impeller from the shaft.

MOTORS

The pump motors shall be vertical, solid shaft, NEMA P-base, squirrel-cage induction type, suitable for _____ phase, _____ cycle, _____ volt electric current. They shall have Class F insulation. Insulation temperature shall, however, be limited to Class B. The motors shall have normal starting torque and low-starting current, as specified by NEMA Design B characteristics. They shall be open drip-proof design with forced air circulation by integral fan. Openings for ventilation shall be uniformly spaced around the motor frame. Leads shall be terminated in a cast connection box and shall be clearly identified.

The motors shall have 1.15 service factor. The service factor shall be reserved for the owner's protection. The motors shall not be overloaded beyond their nameplate rating, at the design conditions, nor at any head in the operating range as specified under Operating Conditions.

The motor-pump shaft shall be centered, in relation to the motor base, within .005". The shaft runout shall not exceed .003".

The motor shaft shall equal or exceed the diameter specified under "main pumps", at all points from immediately below the top bearing to the top of the impeller hub. A bearing cap shall be provided to hold the bottom motor bearing in a fixed position. Bearing housings shall be provided with fittings for lubrication as well as purging old lubricant.

The motor shall be fitted with heavy lifting eyes or lugs, each capable of supporting the entire weight of the pump and motor.

[NOTE TO DESIGNER: CHOOSE FROM THE FOLLOWING MOTOR OPTIONS, IF REQUIRED. DELETE IF NOT REQUIRED]

A. SUPER DUTY MOTORS

The pump motors shall be Premium Efficiency type, per NEMA MG-1 table 12-12, Inverter Ready per NEMA Part 31.4.4.2, with cast-iron frames, and be UL Recognized and CSA Approved. The motor windings shall be 200 C Inverter Spike-Resistant magnet wire and the rotors shall have an epoxy coating for corrosion protection.

B. IMMERSIBLE PUMP MOTORS

The pump motors shall be of special construction and fitted with special seals to enable the motor to be immersed in up to 30' of water for a period of up to three weeks, without water entering the motor cavity. As part of the immersible motor package, a float switch shall be provided in the station to provide indication of water approaching the level of the motors and another float switch shall shut down the motors when the water level reaches them. Each of these floats shall signal alarms and activate alarm lights on the control panel. The alarms shall remain activated until manually reset by switches on the panel. In addition, moisture detectors and high temperature thermostats shall be provided in each motor, as a backup, to shut down the associated pump and to signal alarm conditions and activate alarm lights on the control panel. All of these alarm contacts shall be wired to a terminal strip in the control panel for connection to the Owner's alarm system.

PUMP OPERATION

Starting from a low wet well and no pumps operating, the pump operation sequence is as follows:

ENGINEERING DATA



Smith &
Loveless, Inc.®

14040 West Santa Fe Trail Drive
Lenexa, Kansas 66215-1284

3-Pump Recessed Wet Well
Mounted Pump Station
Specification
May, 2012
Page 5

When the wet well rises to the low level on position, the lead pump shall start. If the flow into the wet well exceeds the capacity of the lead pump, the wet well will rise to a higher elevation, and the lag pump shall then come on and operate in parallel with the lead pump. If the flow into the wet well exceeds the capacity of the lead pump and lag pump operating together, the wet well will continue to rise to an even higher elevation, and the standby pump shall then come on operating in parallel with the lead pump and lag pump.

As the rate of flow to the wet well decreases and the wet well level drops to the low level off position, all pumps will stop.

CONTROLS

The control equipment shall be mounted in a NEMA Type 1 steel enclosure with a hinged access cover. The circuit breakers and control switches shall be operable without opening the access cover.

A grounding-type convenience outlet shall be provided on the side of the cabinet for operation of 115-volt AC devices.

Thermal magnetic air circuit breakers shall be provided for branch disconnect service and short-circuit protection of all motor control and auxiliary circuits.

Magnetic across-the-line starters with under-voltage release and overload coils for each phase shall be provided for each pump motor to give positive protection. Each single-phase auxiliary motor shall be equipped with an over-current protection device in addition to the branch circuit breaker, or shall be impedance protected. All switches shall be labeled and a coded wiring diagram shall be provided.

(OPTIONAL ITEM – CHECK IF REQUIRED)

SINGLE-PHASE 120-VOLT POWER TRANSFORMER [DESIGNER: A STATION MOUNTED CONTROL POWER TRANSFORMER IS REQUIRED FOR ALL STATIONS UNLESS A SEPARATE 1/60/120 SUPPLY FROM A SEPARATE TRANSFORMER (NOT A PHASE-TO-NEUTRAL TAP FROM THE 3-PHASE SUPPLY) IS AVAILABLE. SELECT FROM FOLLOWING CHART:]

<u>SUCTION PIPE SIZE</u>	<u>AUX. HEATER</u>	<u>MIN. TRANSFORMER SIZE</u>
4"	NO	3 KVA 208V
4"	NO	3 KVA 230/460V
4"	YES	5 KVA 208/230/460V
6" OR 8"	NO	5 KVA 208/230/460V
6" OR 8"	YES	7.5 KVA 208/230/460V

A (3) (5) (7.5) KVA insulating-type transformer shall be provided to supply power for lights, controls and auxiliary devices. The transformer shall have 240/480 volt primary, 120/240 volt secondary, Class F insulation, with temperature rise not to exceed 115°C above 40°C ambient. The core and coil assembly shall be given a double dip and bake. The coil shall be protected by a metal housing to prevent damage. The transformer shall be protected by a separate circuit breaker on the supply side.

[NOTE TO DESIGNER: SELECT ONE OF THE FOLLOWING LEVEL CONTROL SYSTEM PARAGRAPHS, A OR B, AND DELETE THE OTHER.]

A. FLOAT SWITCH LEVEL CONTROLS

To control the operation of the pumps with variations of liquid level in the wet well, a minimum of four (4) displacement switches shall be provided. A 30' cord shall be provided with each switch. The cord shall have a corrosion-resistant vinyl jacket and be multi-stranded in order to prevent fatigue. Cord grips shall be located approximately 8" below the manway cover

ENGINEERING DATA



Smith &
Loveless, Inc.®

14040 West Santa Fe Trail Drive
Lenexa, Kansas 66215-1284

3-Pump Recessed Wet Well
Mounted Pump Station
Specification
May, 2012
Page 6

to the wet well to provide for visual inspection and adjustment of the displacement switches.

An automatic alternator with manual switch shall be provided to change the sequence of operation of the pumps every six hours. Alternating the pumps at less than six-hour intervals will not be acceptable.

Provisions shall also be made for the pumps to operate in parallel should the level in the wet well continue to rise above the starting level for the low-level pump.

B. PUMLOGIX™ MICROPROCESSOR LEVEL CONTROL SYSTEM

The liquid level in the wet well shall be monitored by a submersible hydrostatic pressure transducer with stainless steel sensor diaphragm, providing a 4-20 mA signal to the pump control unit. The body of the transducer shall be made of 316 stainless steel. The pressure transducer shall have a permanent hermetically sealed connection to a polyethylene insulated cable, which shall support the transducer 6" from the bottom of the wet well, and shall pass through a cord grip seal in the station base. The pressure transducer unit shall be rated for wastewater or potable water service, and for operation in explosion hazardous areas.

Four (4) displacement switches shall be provided to automatically operate the pump in back-up mode, in case of failure of the digital control system or the submersible level transducer. The back-up system shall be entirely independent of the digital system. A 30' color-coded cord shall be provided with each switch. The cord shall have a corrosion-resistant vinyl jacket and be multi-stranded in order to prevent fatigue. The displacement switch cords and the cable for the submersible pressure transducer shall enter the wet well through cord grip seals.

To control the operation of the pumps with variations of liquid level in the wet well, and the high and low water alarm functions, a specially preprogrammed, dedicated microprocessor-based control system shall be provided. The controller shall interface with the wet well level transducer, integral panel display unit, motor starters and alarm functions, as required.

The digital controls shall operate on 24 volts or less, to eliminate shock hazard. The 24-volt power supply shall be overload protected to be "crowbar safe" and will return to operation when a short is removed.

To reduce exposure to corrosive environments and ensure the control system's reliable, long-term operation, the controller shall have a sealed, user-friendly, graphical interface. The interface shall be comprised of a rotary knob, switches and six (6) columns of ultra-bright, daylight-viewable red LED's. Five (5) 40-segment, 4" columns of LED's shall show the wet well level, the pump on and off control bands, and the high and low alarm setpoint bands. All LED's within a control band shall be illuminated when operating under normal power. A sixth LED column shall indicate the controller's configuration, status, and active alarms. Alarms shall consist of high alarm, low alarm and input signal out of range. Monitor functions shall include control power and normal system operation. Discrete LED's shall show the activation of the differential pump control stages.

The controller shall provide easy, convenient indication and adjustment of the operating setpoints and controller configuration without the need for tools. For ease of operation and configuration, multiple indicating columns are required. Controllers that provide fewer columns; thus, limiting the viewing of relevant and necessary station information, are specifically precluded by this specification.

The pump control circuits shall be forced OFF by power loss. Upon power restoration, the controller shall enable the pumps in an adjustable time-step sequence as required to meet the demand.

The controller shall continuously indicate the status of the selected alternation sequence and control modes. The controller shall provide 1st On/1st Off, Fixed and Auto Rotate alternation sequences.

Integral span, offset, and damping adjustments shall be easily adjustable. The controller shall have a configurable security lockout feature.

The controller shall contain a level simulation function that allows manual manipulation of the displayed process variable.

ENGINEERING DATA



Smith &
Loveless, Inc.®

14040 West Santa Fe Trail Drive
Lenexa, Kansas 66215-1284

3-Pump Recessed Wet Well
Mounted Pump Station
Specification
May, 2012
Page 7

While simulating, the controller shall display both the actual wet well level and the simulated level.

The controller shall contain an RS-232 communication port and have capabilities for connection to a SCADA (Supervisory Control and Data Acquisition) system using Modbus® protocol. The complete assembly shall be designed for use in UL508 Industrial Control Panels.

It is the specific intention of this functional requirement that a controller shall be provided with features as described herein. Additionally, this controller shall be a fully integrated assembly. That is, the furnishing of similar functions using multiple setpoint modules, a custom-configured programmable logic controller (PLC) or extensive relay/timer logic to accomplish control sequences, etc., is specifically precluded by this specification and is not acceptable.

Provisions shall also be made for the pumps to operate in parallel should the level in the wet well continue to rise above the starting level for the low-level pump.

HIGH WET WELL LEVEL ALARM

An adjustable displacement switch shall be provided to sense a high water level condition. The switch shall hang into the wet well and shall activate a contact to indicate the high water condition.

RUNNING TIME METER

A running time meter shall be supplied for each pump to show the number of hours of operation. The meter shall be enclosed in a dust and moisture-proof molded plastic case. The flush-mounted dial shall register in hours and tenths of hours up to 99,999.9 hours before repeating. The meter shall be suitable for operation from a 115-volt, 60-cycle supply.

PUMP FAILURE TO PRIME OR FAILURE TO PUMP ALARM (CHECK VALVE SWITCH TYPE)

To sense failure to deliver normal flow for any reason, including failure to prime, each pump shall be provided with a sealed sensor switch mounted in a protective ABS enclosure. The enclosure shall be mounted with an adjustable universal mounting bracket to the external arm of each discharge check valve. The mounting bracket shall allow the adjustment of the sensor switch with a single locking pivot adjustment. A red LED indicating light shall be provided on each switch unit to facilitate accurate setting of the switch for proper operation. The sensor switch shall monitor the movement of the check valve arm and thereby detect failure of the pump to deliver normal operating flow when called on to run. An auxiliary time delay relay shall be provided to prevent an alarm signal during the pump priming and startup period.

VACUUM-PRIMING SYSTEM

A vacuum priming system shall be furnished to prime the main pumps. The system shall be as shown on the vacuum priming schematic and shall include one vacuum pump for each main pump, providing 100 percent standby. Vacuum pumps shall have corrosion-resistant internal components. The vacuum priming system shall be complete with large port vacuum control solenoid valves, **SONIC START**® prime level sensor, float-operated check valves to protect the vacuum pumps, and all necessary shut-off valves as shown on the piping schematic. The float-operated check valves shall have a transparent body for visual inspection. All hoses and tubing used in the priming system shall be at least 3/8" nominal diameter.

The solenoid valves used in the vacuum priming system shall be of the high flow, direct acting brass body type, with threaded ports, NBR seals and 300 Series stainless steel plunger, rod, plate and springs. The minimum orifice diameter shall be 5/16". The solenoid valves shall be UL Listed, with Class F coil rating and of suitable voltage and thermal capacity for the application.

Liquid level in the pump priming chamber shall be monitored by a **SONIC START**® resonant frequency liquid level probe. The probe shall be equipped with a piezoelectric drive and sensitive circuits to detect frequency shifts when the probe is covered by liquid. The probe shall be completely sealed and have a 316L stainless steel housing for corrosion resistance. It shall be provided with a wiring connector molded of PolyPhenylSulfone, an amorphous high performance thermoplastic for impact and chemical resistance. The probe shall have a plug-in connector to facilitate easy removal.

ENGINEERING DATA



Smith &
Loveless, Inc.®

14040 West Santa Fe Trail Drive
Lenexa, Kansas 66215-1284

3-Pump Recessed Wet Well
Mounted Pump Station
Specification
May, 2012
Page 8

The **SONIC START**® probe shall be provided with light emitting diodes. This diagnostic tool shall indicate connectivity, prime status or a fault condition. Systems utilizing an electrode, mechanical means such as a float, or that require any type of electrical or moving parts inside the priming chamber, which may accumulate debris, short out, bind or fail will not be acceptable.

The priming system shall automatically provide positive lubrication of the mechanical seal each time a main pump is primed. To prevent excessive stoppage due to grease accumulation, no passageway in the priming system through which the pumped liquid must pass shall be smaller than the equivalent of a 2-1/2" opening.

The vacuum priming system shall have two field selectable modes of operation. In the "On-Demand" mode, the priming system will operate only after a pump is called on to run, and if it is not primed. Once primed, the pump will be allowed to run. In the "Constant Prime" mode, both pumps are kept primed continuously, and ready to start immediately when called for.

LIGHTING

A twin 30-watt fluorescent light fixture and guard shall be mounted opposite the control panel to provide adequate illumination for all areas within the equipment chamber.

A manual switch located in the equipment chamber shall be provided to turn the lights and ventilating blower on when the cover is closed.

VENTILATING BLOWER

A ventilating blower shall be provided, capable of delivering (200 cfm) 30 air changes per hour of outside air into the equipment chamber. The blower shall be rigidly mounted to the chamber shell and shall discharge into the station as shown on the plans. It shall be controlled by a percentage timer to provide essentially continuous ventilation.

SUMP PUMP

A submersible sump pump with close-coupled motor shall be installed in the sump. It shall be rated 1000 GPH at design head. A mechanical seal on the shaft shall exclude water from the motor housing. The sump pump shall be controlled automatically by a float switch. It shall discharge into the entryway to the wet well through a steel pipe as shown on the drawings.

MAIN PIPING

The pump suction shall be drilled and tapped for a 125-pound American Standard flange for ready connection of the suction riser. The discharge line from each pump shall be fitted with a clapper-type check valve. The check valve shall be of the spring-loaded type with external lever arm and an easily replaced resilient seat for added assurance against vacuum leaks. Check valves shall have stainless steel shaft with replaceable bronze shaft bushings and shall be sealed with an adjustable Teflon seal.

A four-way plug valve shall be provided as shown on the drawing. The valve shall be capable of isolating any one, two or all three main pumps from the force main. The plug shall be rubber coated for positive operation and shall include corrosion-resistant internal components. A valve operating handle shall be included. The handle will be used to rotate the plug to various reference marks indicating the orientation of the valve ports. The four-way plug valve shall utilize horizontal discharge inlet piping with a common bottom discharge to the force main. Multiple isolation valves connected to a bottom discharge will not be an acceptable substitute unless they can be incorporated in a station of equal or smaller dimensions with equivalent maintenance area.

Pump suction and discharge lines protruding through the floor plate shall be welded tight to affect sealing between the equipment chamber and the wet well. The pump station manufacturer shall extend the piping connections below the floor plate at the factory, so that field connections can be made without disturbing the gas-tight seals.

The manufacturer of the pump station shall provide a compression-type sleeve coupling for installation in the common discharge pipe.

ENGINEERING DATA



Smith &
Loveless, Inc.®

14040 West Santa Fe Trail Drive
Lenexa, Kansas 66215-1284

3-Pump Recessed Wet Well
Mounted Pump Station
Specification
May, 2012
Page 9

The attached pump specification and checklist must be met in total. There are many reasons for incorporating a good pump specification. For example, the stainless steel shaft with tapered impeller attachment is provided to minimize corrosion, extend seal life, and provide ease of impeller removal and seal replacement without the use of a wheel puller. All items specified are for long life, durability and maintainability of the pumping equipment. Deviations from the pump specifications will not be allowed.

A checklist is also provided to insure that the proper pumping system is provided to the owner.

FACTORY TESTS

All components of the pump station shall be given an operational test at the pump station manufacturer's facility to check for excessive vibration, for leaks in the piping or seals and correct operation of the automatic control and vacuum priming systems and all auxiliary equipment. Installed pumps shall take suction from a deep wet well, simulating actual service conditions. The control panel shall undergo both a dry logic test and a full operational test with all systems operating.

Factory test instrumentation must include flow measuring with indicator; compound suction gauge; Bourdon tube-type discharge pressure gauge; electrical meters to measure amperes, volts, kilowatts and power factor; speed indicator and a vibrometer capable of measuring both amplitude and frequency.

SPARE PARTS

A complete replacement pump shaft seal assembly shall be furnished with each pump station. The spare seal shall be packed in a suitable container and shall include complete installation instructions. A spare volute gasket and seal gasket shall be provided.

An instructional video presentation on the pump mechanical seal system in DVD format shall be included. The DVD shall contain a presentation on the following subjects: purpose and location of the mechanical seal, signs of a defective mechanical seal, how to remove the mechanical seal, troubleshooting seal failure causes, seal components, required tools, how to reinstall the seal and how to place the pump back into service. The video shall include footage of an actual seal replacement.

INSTALLATION AND OPERATING INSTRUCTIONS

Installation of the pump chamber shall be done in accordance with the written instructions provided by the manufacturer.

Operation and maintenance manuals shall be furnished, which will include parts lists of components, complete service procedures and troubleshooting guide.

STARTUP

The manufacturer shall provide the services of a factory-trained representative for a maximum period of one (1) day on-site to perform initial startup of the pump station and to instruct the owner's operating personnel in the operation and maintenance of the equipment.

WARRANTY

The manufacturer of the station shall warrant for one (1) year from date of start-up, not to exceed eighteen (18) months from date of shipment, that the structure and all equipment he provides will be free from defects in material and workmanship. Warranties and guarantees of the suppliers of various components in lieu of a single source responsibility by the Manufacturer will not be accepted. The Manufacturer shall assume prime responsibility for the warranty of the station and all components.

In the event a component fails to perform a specified or is proven defective in service during the warranty period, the Manufacturer shall repair or replace, at his discretion, such defective part. He shall further provide, without cost, such labor as may be required to replace, repair or modify major components such as the steel structure, main pumps, main pump motors and main piping manifold. After start-up service has been performed, the labor to replace accessory items, such as the blower, priming pumps, alternator, etc., shall be the responsibility of others.

ENGINEERING DATA



Smith &
Loveless, Inc.®

14040 West Santa Fe Trail Drive
Lenexa, Kansas 66215-1284

3-Pump Recessed Wet Well
Mounted Pump Station
Specification
May, 2012
Page 10

The repair or replacement of those items normally consumed in service, such as seals, grease, light bulbs, etc., shall be considered as part of routine maintenance and upkeep.

It is not intended that the Manufacturer assume responsibility for contingent liabilities or consequential damages of any nature resulting from defects in design, material, workmanship or delays in delivery, replacement or otherwise.

MANUFACTURER'S INSURANCE

All equipment manufacturers, either direct or subcontractors to the general or mechanical contractors, SHALL HAVE in effect at TIME OF BID, CONTRACT AWARD, CONTRACT PERFORMANCE, and WARRANTY TERM, PRODUCT AND COMPREHENSIVE LIABILITY INSURANCE, INCLUDING SUDDEN AND ACCIDENTAL POLLUTION COVERAGE in the amount of FIVE MILLION DOLLARS, \$5,000,000 through an insurance company with a minimum rating of A+ (SUPERIOR) XV according to the BEST'S INSURANCE REPORTS. All policies must be written on an OCCURRENCE BASIS. Policies written on a CLAIMS MADE BASIS are not acceptable. A typical CERTIFICATE OF INSURANCE attesting to the specified coverage issued by the responsible carrier naming the ENGINEER OF RECORD and the OWNER as ADDITIONAL INSURED, must be presented to the named additional insured prior to contract award. A FAILURE TO COMPLY with this requirement BY THE BIDDER will require DISQUALIFICATION of the BID and CONTRACT AWARD.

MANUFACTURED EQUIPMENT

OPTION 1 (STANDARDIZATION) [DELETE THIS LINE FROM THE FINAL SPEC]

The specifications and drawings detail Smith & Loveless equipment and represent the minimum standard of quality for both equipment and materials of construction. The contractor shall prepare his bid on the basis of the particular equipment and materials specified for the purpose of determining the low bid.

The owner has standardized on the named equipment in order to optimize their operation, maintenance, and safety programs, provide for interchangeability of costly equipment items, reduce stocking levels required for necessary spare parts and provide increased flexibility in the utilization of their pumping stations. Equipment substitutions, since incompatible with the districts standardization program, will not be considered.

OPTION 2 (BASE BID WITH THE BID SUBMITTAL) [DELETE THIS LINE FROM THE FINAL SPEC]

The specifications and drawings detail Smith & Loveless equipment and represent the minimum standard of quality for both equipment and materials of construction. The contractor shall prepare his bid on the basis of this equipment for the purpose of determining the low bid, without consideration of a possible substitute.

Substitution of other makes may be considered if the equipment proposed for substitution is superior or equal in quality and efficiency to the standards of quality named in the specifications and this is demonstrated to the satisfaction of the engineer.

Contractors wishing to offer a deduct for substitute equipment shall include the following submittal information with their proposal.

BID SUBMITTAL

This submittal shall include all necessary information for the proper determination of the acceptability of the proposed substitution and shall not necessarily be limited to the following:

- A. Complete description of the equipment, system, process, or function, including a list of system components and features, drawings, catalog information and cuts, manufacturers specifications, including materials description.
- B. Performance data and curves and horsepower requirements.
- C. Outside utility requirements, such as water, power, air, etc.
- D. Functional description of any internal instrumentation and control supplied including list of parameters monitored, controlled, or alarmed.

ENGINEERING DATA



Smith &
Loveless, Inc.®

14040 West Santa Fe Trail Drive
Lenexa, Kansas 66215-1284

3-Pump Recessed Wet Well
Mounted Pump Station
Specification
May, 2012
Page 11

- E. Addresses and phone numbers of nearest service centers and a listing of the manufacturers or manufacturers representatives services available at these locations, including addresses and phone numbers of the nearest parts warehouses capable of providing full parts replacement and/or repair services.
- F. A list of five (5) installations in the states where similar equipment by the manufacturer is currently in similar service; include contact name, telephone number, mailing address of the municipality or installation, engineer, owner, and installation contractor; if five installations do not exist, the list shall include all that do exist, if any.
- G. Detailed information on site, architectural, structural, mechanical, plumbing, electrical, and control, and all other changes or modifications to the design and construction work necessary to adapt the equipment or systems to the arrangement shown and/or functions described on the drawings and in the space requirements necessary to provide the minimum adequate clear space within and around the equipment for operation and maintenance, as shown on the drawings and specified.
- H. All differences between the specifications and the proposed substitute equipment shall be clearly stated in writing under a heading of differences.
- I. Other specific submittal requirements listed in the detailed equipment and material specifications.
- J. A completed and signed copy of the "Pump Station Certification Affidavit" which follows.

EVALUATION

Approval of the substitution to bid as an alternate shall in no way relieve the contractor from submitting the specified shop drawings for approval or complying fully with all provisions of the specifications and drawings.

If substituted equipment is accepted, the contractor shall, at his own expense, make any changes in the structures, piping, electrical, etc. necessary to accommodate the equipment. If engineering is required due to substitution of alternate equipment, the contractor shall pay for all engineering charges.

To receive final consideration, copies of the manufacturer's quotations for the equipment may be required to document the savings to the satisfaction of the engineer. It is the intent that the owner shall receive the full benefit of the savings in cost of equipment and the contractors bid price shall be reduced by an amount equal to the savings. In all technical and other evaluations, the decision of the engineer is final.

TYPICAL BID FORM

[ADD TO BID FORM AS APPLICABLE TO ABOVE SELECTED OPTION]

OPTION 1

For reasons of standardization, bids shall be based on the named equipment. Alternate bids will not be allowed.

OPTION 2

The bid shall be based on the named equipment. Alternate/substitute equipment may be offered as a deduct, provided all conditions of the "manufactured equipment" section are met.

Alternate/substitute manufacturer _____

Deduct \$

ENGINEERING DATA



Smith &
Loveless, Inc.®

14040 West Santa Fe Trail Drive
Lenexa, Kansas 66215-1284

3-Pump Recessed Wet Well
Mounted Pump Station
Specification
May, 2012
Page 12

PUMP STATION CERTIFICATION AFFIDAVIT

(Two-Port Impeller)

A submittal to the owner by manufacturers proposing alternate, unnamed pump stations will be required with their bid. Included in the submittal shall be detailed drawings and specifications on the proposed pump station. The bid submittal shall include the following completed checklist signed by an officer of the company.

	YES	NO
Close-coupled pump design - no motor to pump shaft coupling		
Pump shaft diameter of _____ minimum through seal		
Full diameter impeller shrouds		
Stainless steel pump shaft with tapered shaft to impeller fit		
Maximum pump shaft overhang of 6"- lower bearing to impeller		
Bronze seal housing		
Minimum pump efficiency at design point of _____ GPM of _____ %		
Impeller eye and ports pass a 3" sphere		
Class F motor insulation with Class B max motor temperature rise and 1.15 service factor		
Motor shaft run-out 0.003" max at end of shaft		
Motor shaft centered to motor base with 0.005"		
Locked lower bearing and floating upper bearing		
One-piece motor adapter/backhead		
Motor HP of _____ at _____ RPM		
Complete pump station factory tested on a wet well		
Priming from low pressure area behind the impeller		
Resonant frequency pump prime detection system		
Transparent priming bowl for operator monitoring		
Hollow priming adapter for positive seal lubrication		
Completely separate priming system for each pump		
Minimum 2-1/2" equivalent opening in priming passageways		
All other items for the station, as specified with minimum sizes, capacities and materials indicated		
Product liability insurance, \$5 million per specification		
Structure blasted with steel grit in environmentally controlled booth prior to coating with epoxy resin		

The consulting engineer shall be the sole judge of whether the proposed equipment is acceptable. The manufacturer shall have the responsibility of submitting sufficient information in one submission. Incomplete or inaccurate submittal data shall be cause for rejection of the proposed equipment.

By signing this affidavit, the officer of the company has stated 100% compliance with the plans and specifications and further states he will supply or pay for all deficiencies found in the job submittals or after the unit is installed. The consulting engineer shall be the sole judge regarding compliance with the plans and specifications and shall be sole judge on the amount of moneys required if any deficiencies are found, related to, but not limited to, a 20-year station design life.

Signature of Company Officer

Corporate Seal
(Notarized)

Title

ENGINEERING DATA



Smith &
Loveless, Inc.®

14040 West Santa Fe Trail Drive
Lenexa, Kansas 66215-1284

3-Pump Recessed Wet Well
Mounted Pump Station
Specification
May, 2012
Page 13

PUMP STATION CERTIFICATION AFFIDAVIT

(X-PELLER® Mono-Port Impeller)

A submittal to the owner by manufacturers proposing alternate, unnamed pump stations will be required with their bid. Included in the submittal shall be detailed drawings and specifications on the proposed pump station. The bid submittal shall include the following completed checklist signed by an officer of the company.

	YES	NO
Close-coupled pump design - no motor to pump shaft coupling		
Pump shaft diameter of _____ minimum through seal		
Full diameter impeller shrouds		
Stainless steel pump shaft with tapered shaft to impeller fit		
Maximum pump shaft overhang of 6" - lower bearing to impeller		
Bronze seal housing		
Minimum pump efficiency at design point of _____ GPM of _____ %		
Impeller eye and port pass a 3" sphere		
Impeller of mono-port design with a minimum area of 10.6 square inches		
Trimming of impeller vane does not alter dynamic balance		
Impeller dynamically balanced without use of weights or liquid filled chambers		
Class F motor insulation with Class B max motor temperature rise and 1.15 service factor		
Motor shaft run-out 0.003" max at end of shaft		
Motor shaft centered to motor base with 0.005"		
Locked lower bearing and floating upper bearing		
One-piece motor adapter/backhead		
Motor HP of _____ at _____ RPM		
Complete pump station factory tested on a wet well		
Priming from low pressure area behind the impeller		
Resonant frequency pump prime detection system		
Transparent priming bowl for operator monitoring		
Hollow priming adapter for positive seal lubrication		
Completely separate priming system for each pump		
Minimum 2-1/2" equivalent opening in priming passageways		
All other items for the station, as specified with minimum sizes, capacities and materials indicated		
Product liability insurance, \$5 million per specification		
Structure blasted with steel grit in environmentally controlled booth prior to coating with epoxy resin		

The consulting engineer shall be the sole judge of whether the proposed equipment is acceptable. The manufacturer shall have the responsibility of submitting sufficient information in one submission. Incomplete or inaccurate submittal data shall be cause for rejection of the proposed equipment.

By signing this affidavit, the officer of the company has stated 100% compliance with the plans and specifications and further states he will supply or pay for all deficiencies found in the job submittals or after the unit is installed. The consulting engineer shall be the sole judge regarding compliance with the plans and specifications and shall be sole judge on the amount of moneys required if any deficiencies are found, related to, but not limited to, a 20-year station design life.

Signature of Company Officer

Corporate Seal
(Notarized)

Title

ENGINEERING DATA



Smith &
Loveless, Inc.®

14040 West Santa Fe Trail Drive
Lenexa, Kansas 66215-1284

3-Pump Recessed Wet Well
Mounted Pump Station
Specification
May, 2012
Page 14

ADDITIONAL ACCESSORY OPTIONS [DESIGNER: SELECT AS REQUIRED]

LOW WET WELL LEVEL ALARM

An adjustable displacement switch shall be provided to sense a low water level condition. The switch shall hang into the wet well and shall activate a contact to indicate the low water condition.

RUNNING TIME METER FOR PARALLEL OPERATION

A third running time meter shall be supplied to show the number of hours of operation with both pumps running in parallel. The meter shall be enclosed in a dust and moisture-proof molded plastic case. The flush mounted dial shall register in hours and tenths of hours up to 99,999.9 hours before repeating. The meter shall be suitable for operation from a 115-volt, 60-cycle supply.

PUMP RUNNING LIGHTS

A green panel light to indicate "Pump On" shall be provided for each main pump.

120V ALARM LIGHT

A vapor-proof light fixture with 50-watt lamp for outdoor pole mounting shall be provided with a red globe and guard.

120V ALARM LIGHT WITH FLASHER

A vapor-proof light fixture with 50-watt flashing lamp for outdoor pole mounting shall be provided. The light shall flash during alarm conditions. The fixture shall be complete with a red globe and guard.

120V ALARM BELL

A vibratone-type bell mounted on a weather-tight box suitable for pole mounting shall be provided.

120V ALARM HORN

A vibratone-type horn mounted on a weather-tight box suitable for pole mounting shall be provided.

12V TRICKLE CHARGER

Storage batteries and charger shall be supplied to furnish power for operating alarm annunciators in cases of power failure. The storage batteries (two 3-cell, 6-volt) shall be maintenance-free lead-calcium battery concealed in high impact, heat-resistant and permanently sealed containers. The battery charger shall be solid-state, capable of restoring battery to full charge within 12 hours after a discharge, not exceeding 1.5 hours. Brownout protection is standard, and will activate the unit when AC line voltage drops below 85 volts.

12V ALARM LIGHT

A vapor-proof light fixture with 50-watt lamp for outdoor pole mounting shall be provided with a red globe and guard.

12V ALARM BELL

A vibratone-type bell mounted on a weather-tight box suitable for pole mounting shall be provided.

12V ALARM HORN

A vibratone-type horn mounted on a weather-tight box suitable for pole mounting shall be provided.

PANEL MOUNTED AUTOMATIC RESET ALARM SILENCE SWITCH

A momentary contact alarm silencing switch mounted on the control panel shall be provided. The alarm shall automatically be reset when the alarm condition is removed.

ENGINEERING DATA



Smith &
Loveless, Inc.®

14040 West Santa Fe Trail Drive
Lenexa, Kansas 66215-1284

3-Pump Recessed Wet Well
Mounted Pump Station
Specification
May, 2012
Page 15

REMOTE MOUNTED AUTOMATIC RESET ALARM SILENCE SWITCH

A momentary contact alarm silencing switch mounted in a weatherproof box suitable for pole mounting shall be provided. The alarm shall automatically be reset when the alarm condition is removed.

REMOTE ALARM CONTACTS

In addition to the common, powered local alarm connection, individual unpowered contacts shall be provided and wired to a terminal strip for field connection to a remote alarm monitoring system (not included).

ALARM DIALER INTERFACE (DIALER NOT INCLUDED)

Provisions shall be made within the pump station to facilitate the field installation of an alarm dialer, which is to be furnished and installed by others. The alarm dialer shall be as described elsewhere in these specifications. The factory built pump station shall be provided with a mounting bracket approximately 12 inches by 10-5/8 inches to attach and support the alarm dialer, near the station control panel, beneath the fiberglass enclosure. In addition, openings for conduit connections shall be provided in the bottom of the station control panel and through the side of the station base, to facilitate wiring of the alarm dialer input, output and power connections. In addition to the powered common local alarm contact, the station control panel shall have terminal strip connections for fault-opening alarm contacts to provide discrete alarm input signals to the dialer and shall also include terminal strip connections for a 1/60/120 volt power source, on a separate 15-amp circuit, to power the dialer. Wiring of the dialer shall be done by others during installation of the station in the field.

BASE1-BASE2-AUTO ALTERNATE SELECTOR SWITCH

A 3-position selector switch shall be mounted on the face of the control panel to allow selection of either pump as the lead pump, or to allow for automatic alternation.

SURGE PROTECTIVE DEVICE

A surge protective device for lightning and surge protection with an internal automatic discharge circuit and rated for three-phase service shall be provided.

TIME DELAY

The pump control system shall provide for a time delay to prevent simultaneously starting the pump motors after power failure.

SEQUENTIAL ALTERNATION

In lieu of the timed alternation system, provisions shall be made to alternate the pumps at the completion of each pumping cycle.

GENERATOR INTERLOCK

Provisions shall be made in the control circuit of the lift station to facilitate locking out the standby pump when the emergency generator set is powering the station. An interlock consisting of a normally closed auxiliary contact shall be supplied with the emergency generator controls by the generator manufacturer. This normally closed contact shall be wired to the terminal blocks provided in the lift station control panel by the lift station manufacturer. The interconnecting wiring shall be supplied and connected by the installing contractor.

ADD-A-PHASE INTERFACE

Terminals shall be provided in the lift station control panel to facilitate connection to an external Add-A-Phase phase converter unit.

ROTO PHASE INTERFACE

Terminals and a time delay to prevent simultaneously starting the pump motors after power failure shall be provided in the lift station control panel to facilitate connection to an external Roto Phase phase converter unit.

ENGINEERING DATA



Smith &
Loveless, Inc.®

14040 West Santa Fe Trail Drive
Lenexa, Kansas 66215-1284

3-Pump Recessed Wet Well
Mounted Pump Station
Specification
May, 2012
Page 16

INTRINSICALLY SAFE CONTROL

Intrinsically safe relays to provide low current isolated switching for the float switches shall be provided.

MAIN CIRCUIT BREAKER

A main circuit breaker shall be installed in the control panel to provide over-current protection for the station, and shall be capable of being used to disconnect the three-phase power to the pump station. The breaker shall be operable without opening the panel, and shall be interlocked with the panel door. It shall be capable of being padlocked in the “Off” position.

SOLID-STATE REDUCED VOLTAGE STARTERS

UL listed, solid-state reduced voltage starters shall be supplied. The starters shall be capable of a soft start and soft stop. The starters shall have built in overload protection as well as built in bypass contactors. One set of form C auxiliary contacts shall be supplied on the starter. The starters shall be powered by 24V DC and shall have a built-in Digital Signal Processor utilizing a low impedance run circuit. The starters shall be easily programmable by using a standard screwdriver.

PHASE MONITOR

A relay with double pole, double throw contacts shall be provided to monitor and protect against phase loss (single-phasing), under voltage (brownouts) and phase reversal (improper sequence). It shall automatically reset when three-phase service returns to normal.

SINGLE-PHASE POWER MONITOR

A single pole, double throw relay shall be provided to monitor the 120V single-phase control power supply and initiate an alarm on loss of power. It shall automatically reset when the single-phase service returns to normal.

PUMP PRIME FAILURE

A time delay relay shall be connected to each vacuum pump. Contacts shall be provided to automatically shut down the operating vacuum pump, allow starting of the next pump in the operating sequence and signal an alarm on excessive vacuum pump operating time. Contacts shall be provided for transmitting an alarm signal.

OPERATOR ASSIST ALARM

The station control panel shall be provided with a maintained contact, manually operated, red mushroom head Operator Assist Alarm Button in an easily accessible position on the control panel to signal emergency operator assistance is required. It also may be used to provide means for testing the alarm system.

UNAUTHORIZED ENTRY ALARM

A timer circuit shall be provided in the control panel to signal unauthorized entry into the pump station. The timer shall be activated whenever the fiberglass cover is opened. A key-operated switch shall be provided on the station control panel to provide authorized personnel a means to deactivate the alarm before the timer completes its cycle.

NEMA STARTERS

NEMA rated magnetic across-the-line starters with overload protection for each phase shall be provided for each pump motor to give positive protection against phase unbalance, thermal overload, phase loss and ground fault.

AUXILIARY STATION HEATER

A 1300/1500 watt, dual range, electric heater with automatic circulating fan, thermostat control and an On/Off switch is to be provided. The heater is to be operated by connection to the station convenience receptacle.

INSULATED HOOD

The fiberglass cover shall have a minimum of 1” thick urethane insulation, protected by fiberglass, with an “R” value of 7 or more.

ENGINEERING DATA



Smith &
Loveless, Inc.®

14040 West Santa Fe Trail Drive
Lenexa, Kansas 66215-1284

3-Pump Recessed Wet Well
Mounted Pump Station
Specification
May, 2012
Page 17

AUTOMATIC LID SWITCH FOR LIGHTS

A switch mounted beneath the station's fiberglass cover shall be actuated when the cover is opened and automatically turn on the station lights and ventilation blower.

CERTIFIED CURVES

Factory certified performance test curves shall be provided for the pumps and tested after installation in the station to stimulate actual operating conditions. Copies of these curves, showing head, flow, BHP, efficiency and the backup data shall be provided with the station. Typical data or curves from a similar pump are not acceptable. Data and curves must be for the actual pumps provided, and while mounted in the station.

STATION FLOODING ALARM

A float-operated switch shall be mounted near the station floor to detect accumulation of liquid above the normal sump pump operating level, and send an alarm signal.

DEHUMIDIFIER

A dehumidifier assembly with hermetically sealed Freon refrigeration-type compressor, expansion coil, fan and condenser coil shall be furnished to maintain the relative humidity of the air in the pump chamber low enough to keep the electrical equipment dry and to prevent condensation on the walls.

The moisture removing capability of the dehumidifier will vary with the temperature and relative humidity within the station. The minimum capacity rating at 80°F and 68% relative humidity shall be 15.5 pints per day. The maximum capacity of 80°F and 90% relative humidity shall be 25 pints per day. The dehumidifier shall be controlled automatically by an adjustable humidistat. The dehumidifier shall be located on the station floor and the condensate drained to the sump.

MANWAY LADDER

An aluminum ladder shall be provided in the manway portion of the station, to facilitate access.

MANWAY LADDER SAFETY DEVICE

A 36" extendable bar shall be fitted to the manway ladder, to provide easier entry, when raised.

ADDITIONAL ANODES

____ Additional magnesium anodes (for a total of ____) shall be provided with the station for cathodic protection.

WET WELL BLOWER

A ventilating blower capable of delivering 100 CFM shall be provided for ventilation of the wet well. The wet well blower shall be enclosed in a NEMA 3R rain-tight cabinet with a louvered cover and shall be mounted on the station base adjacent to the manway access hatch. A manual switch on the control panel shall operate the blower.

PROTECTED LIQUID FILLED COMPOUND PRESSURE GAUGES

A four-inch (4") Bourdon tube-type compound vacuum/pressure gauge with 3-1/2" dial, fitted with a brass stop valve and a manual air relief valve shall be provided for each pump. The gauges shall be mounted apart from the pumps, on a bracket attached to the control panel support structure, and connected to the pump discharge taps by flexible tubing, to minimize vibration. The range of each gauge shall be selected to place the normal operating discharge pressure reading in the middle one-third of the scale and the gauge shall also be capable of measuring up to 30" HG of vacuum. The dial shall be white with black markings and the gauge itself shall have an accuracy of 1% of scale. The gauge shall be American made, with a Zytel Nylon case with 1/2" blowout plug, stainless steel bezel, acrylic lens and phosphorus bronze tube with brass socket. Each compound gauge shall be filled with a viscous fluid to dampen vibration and pulsation effects on the needle reading. Temperature compensation shall be provided by an internal compensating diaphragm. Gauges shall be protected from the service fluid by a Buna-N elastomer "boot" diaphragm within the stem, and the Bourdon tube and the space between the Bourdon tube and the internal isolating diaphragm shall be filled with low temperature instrument oil, completely isolating the

ENGINEERING DATA



Smith &
Loveless, Inc.®

14040 West Santa Fe Trail Drive
Lenexa, Kansas 66215-1284

3-Pump Recessed Wet Well
Mounted Pump Station
Specification
May, 2012
Page 18

gauge components from the fluid being measured.

EMERGENCY PUMPING CONNECTION

The common discharge pipe of the pump station shall be fitted with a branch with a plug valve and male quick-connect fitting with cap, as shown on the drawings, to facilitate connection of a portable emergency pump to the force main, to bypass the pump station. The emergency pumping connection shall be housed within the fiberglass cover.

TOOLKIT

A metal toolbox complete with the following tools shall be provided. This complement of tools shall include all tools necessary to replace the pump mechanical seal.

9/16" x 1/2" Box End Wrench
3/4" x 5/8" Open End Wrench
15/16" x 1" Open End Wrench
1-1/8" Socket
8" T-Handle 11" x 1/2" Drive
1/2" x 5-1/2" Drive Extension
6" Pipe Wrench
#3 Rawhide Mallet
Ratchet-Type Hoist
Motor Lifting Bar
Lint-Free Cloth
Multi-Purpose Grease

ADDITIONAL SPARE MECHANICAL SEALS

In addition to the one standard spare mechanical seal, ____ additional spare mechanical seal(s) shall be provided. The spare seal(s) shall be packed in a suitable container and shall include complete installation instructions.

TEST UNIT WITH BATTERY FOR MULTI-SENSOR CHECK VALVE SWITCH [FOR USE WITH RELAY LOGIC CONTROLS. NOT REQUIRED WITH PROTRONIX® II OR PUMLOGIX™ CONTROLLERS]

To test or set the multi-sensor check valve switches, using the built-in LED light, with Relay Logic control systems, a separate, hand held, battery pack, with connecting cord and plug, shall be provided. This is to enable the operator to accurately set the trip point of the switch manually, by means of the built-in test light on the multi-sensor.

ENGINEERING DATA



Smith &
Loveless, Inc.®

14040 West Santa Fe Trail Drive
Lenexa, Kansas 66215-1284

Series Wet Well
Mounted Pump Station
With 2 Non-Clog Series
Pump Sets Specification
Specification
May, 2012
Page 1

SPECIFICATION SERIES WET WELL MOUNTED PUMP STATION WITH TWO NON-CLOG SERIES PUMP SETS

GENERAL

The contractor shall furnish and install one (1) factory-built, automatic pumping station as manufactured by Smith & Loveless, Inc., Lenexa, Kansas. The station shall be complete with all needed equipment, factory-installed on a welded steel base with fiberglass cover.

The principal items of equipment shall include four vertical, close-coupled, motor driven, vacuum primed, non-clog pumps; valves; internal piping; central control panel with circuit breakers; motor starters and automatic pumping level controls; heater; ventilating blower; priming pumps with **SONIC START**® pump prime detection system and appurtenances; and all internal wiring.

OPERATING CONDITIONS

Each pump shall be capable of delivering _____ GPM of raw water or wastewater against a total dynamic head of _____ feet. The minimum acceptable pump efficiency at this condition shall be _____ %. Due to the energy conservation requirements, the minimum efficiency will be enforced. The maximum allowable speed shall be _____ RPM. The minimum rated horsepower of each pump motor shall be _____. The maximum static suction lift shall be _____. Two pumps operating in series shall deliver _____ GPM at _____ TDH.

All openings and passages shall be large enough to permit the passage of a sphere 3" in diameter. The anticipated operating head range is from _____ feet minimum to _____ feet maximum. The pump motors shall not be overloaded beyond their nameplate rating, at the design conditions, nor at any head in their respective operating range.

CONSTRUCTION

The station shall be constructed in one complete factory-built assembly. It shall be sized to rest on the top of the wet well as detailed on the drawings. The supporting floor plate shall be minimum 1" thick steel with reinforcing, as required, to prevent deflection and ensure an absolutely rigid support.

The pump station shall be enclosed by a two piece hinged fiberglass cover. The cover shall have a suitable drip-lip around the edge and shall be provided with means to allow the pump chamber to be locked with padlocks.

Each cover shall be attached with a multi segment stainless steel hinge, constructed of 7 gauge (minimum) Type 304 stainless steel with a 3/8" diameter stainless steel pin and supporting at least 75% of the width of one end. Stainless steel bolts with tamperproof heads and a full width 3/8" thick anodized aluminum backing plate shall anchor the hinge to the fiberglass cover.

Dual high-pressure gas struts shall be provided to counteract the dead weight of the cover assembly and limit the maximum lifting force required for opening to less than 20 pounds. The cover shall be self-latching upon opening, with a manually operated release for closing. Duplex heavy gauge safety chains shall be provided to prevent over-extension. All hardware and components of the cover assembly that are exposed to the weather shall be constructed of corrosion resistant materials.

A 1/4" thick sliding aluminum manway cover located exterior to the fiberglass pump chamber shall be provided, complete with padlocking provisions. The manway shall be an integral part of the station floor plate and provide access to the wet well.

ENGINEERING DATA



Smith &
Loveless, Inc.®

14040 West Santa Fe Trail Drive
Lenexa, Kansas 66215-1284

Series Wet Well
Mounted Pump Station
With 2 Non-Clog Series
Pump Sets Specification
Specification
May, 2012
Page 2

The pump volutes and discharge piping shall be mounted in relation to the floor plate as detailed on the drawings.

Enclosures utilized to house the valve train and/or controls which are defined under OSHA Article 29CFR, Part 1910 as a Confined Space shall not be acceptable.

A stanchion with lifting arm shall be provided to lift each pump. The lifting arm shall have a hook over the center of the motor to support a hoist (Provided by others) for removal of the motors, impellers and pumps from the station.

□ DURO-LAST® Corrosion-Resistant Stainless Steel Baseplate [Optional Item. Designer Check If Required]

The baseplate of the pump station structure shall be fabricated of corrosion-resistant lean duplex series 2100 stainless steel alloy, 316L stainless steel or equal. The stainless steel shall have a Pitting Resistance Equivalent Number (PRE_N) of 24.0 or greater and general corrosion resistance shall be less than or equal to 0.1 mm per year in 15% H_2SO_4 at 120 degrees F. Due to the corrosion resistance requirements, Grade 304-304L is not acceptable.

The stainless steel surfaces shall be glass bead blast cleaned to remove surface contamination and provide a uniform finish.

The manufacturer of the station shall warrant the stainless steel baseplate for twenty-five (25) years from date of shipment against structural failure and perforation due to corrosion.

WELDING

All steel structural members shall be joined by electric arc welding with welds of adequate section for the joint involved.

PROTECTION AGAINST CORROSION

All Structural steel surfaces shall be factory blasted to remove rust, mill scale, weld slag, etc. All weld spatter and surface roughness shall be removed by grinding. Surface preparation shall comply with SSPC-SP6 specifications. Immediately following cleaning, a single 6-mil dry film thickness of **VERSAPOX®** epoxy resin shall be factory applied. This coating shall be as formulated by Smith & Loveless for abrasion and corrosion resistance.

Stainless steel, aluminum and other corrosion resistant surfaces shall not be coated. Carbon steel surfaces not otherwise protected shall be coated with a suitable non-hardening rust preventative compound. Auxiliary components, such as the electrical enclosure, ventilating blower and vacuum pumps, shall be furnished with the original manufacturer's coating.

Finish coating shall be accomplished prior to shipment of the station from the factory and shall comply fully with the intent of these specifications. A touch-up kit shall be provided by the pump station manufacturer for repair of any mars or scratches occurring during shipping and installation. This kit shall contain detailed instructions for use and shall be the same material as the original coating.

MAIN PUMPS

The pumps shall be (4") vertical, centrifugal non-clog type of heavy cast-iron construction, especially designed for the use of mechanical seals and vacuum priming. In order to minimize seal wear caused by linear movement of the shaft, the shaft bearing nearest the pump impeller shall be locked in place so that end play is limited to the clearance within the bearing. To minimize seal wear resulting from shaft deflection caused by the radial thrust of the pump, the shaft from the top of the impeller to the lower bearing supporting the impeller shall have a minimum diameter of 1-7/8" for motor frame sizes 213 through 286; 2-1/8" for motor frame sizes 324 and 326; and 3" for frame 364 and larger. The dimension from the lowest bearing to the top of the impeller shall not exceed 6".

ENGINEERING DATA



Smith &
Loveless, Inc.®

14040 West Santa Fe Trail Drive
Lenexa, Kansas 66215-1284

Series Wet Well
Mounted Pump Station
With 2 Non-Clog Series
Pump Sets Specification
Specification
May, 2012
Page 3

The oversized shaft incorporating oversized bearings and heavier bearing frame construction provides for extended mechanical seal, bearing and overall pump/motor life. Since the larger shaft with the specified minimum overhang is the key to heavier, more rigid construction throughout, no deviation from the specified shaft diameter or tolerances will be allowed.

The bearing nearest the impeller shall be designed for the combined thrust and radial load. The upper bearing shall be free to move in a linear direction with the thermal expansion of the shaft and shall carry only radial loads.

The shaft shall be solid stainless steel through the mechanical seal to eliminate corrosion and abrasive rust particles. Removable shaft sleeves will not be acceptable if the shaft under the sleeve does not meet the specified minimum diameter.

The pump shall have an adapter providing a large water reservoir above the impeller to provide for positive exclusion of air from the impeller. The seal shall be inside this area to assure lubrication. Pumps which do not use hollow priming adapters for positive lubrication of the seal will not be acceptable.

The pump shall be constructed so as to permit priming from the lower pressure area behind the impeller. Priming from high-pressure connections, which tends to cause solids to enter and clog the priming system, will not be acceptable. The priming bowl shall be transparent, enabling the operator to monitor the priming level.

The pump shall be arranged so that the rotating element can easily be removed from the casing without disconnecting the electrical wiring or disassembling the motor, impeller, backhead or seal, so that any foreign object may be removed from the pump or suction line.

The pump shaft shall be sealed against leakage by a single mechanical seal constructed so as to be automatically drained and primed each time the pump is drained and primed. Water which lubricates the mechanical seal shall be automatically drained from around the seal if the pump loses prime in order to allow both the pump and the seal to be drained, thereby preventing freezing and breakage of the seal during power outages in sub-freezing temperatures.

The seal shall be of carbon and ceramic materials with the mating surfaces lapped to a flatness tolerance of one light band. The rotating ceramic shall be held in mating position with the stationary carbon by a stainless steel spring. The entire seal assembly shall be held in place by a bronze seal housing to prevent excessive heat build-up. Use of cast-iron or other ferrous material for the seal housing which will rust and damage the seal, shortening its life, will not be acceptable.

The pump volute shall be furnished with mounting lugs and bolted to the station floor plate, forming a gas-tight seal.

[NOTE TO DESIGNER: SELECT ONE OF THE FOLLOWING PUMP TYPE PARAGRAPHS, A OR B, AND DELETE THE OTHER. CHECK PUMP CURVES FOR PROPER APPLICATION]

A. NON-CLOG TWO-PORT IMPELLER PUMP (OPTION)

The pump impeller shall be of the enclosed two-port type made of close-grained cast-iron and shall be balanced. The eye of the impeller as well as the ports shall be large enough to permit the passage of a sphere 3" in diameter in accordance with nationally recognized codes. The impeller shall be keyed with a stainless steel key and secured to the motor shaft by a stainless steel capscrew equipped with a Nylock or other suitable self-locking device. The impeller shall not be screwed or pinned to the motor pump shaft and shall be readily removable without the use of special tools. To prevent the buildup of stringy materials, grit and other foreign particles around the pump shaft, all impellers less than full diameter shall be trimmed inside the impeller shrouds. The shrouds shall remain full diameter so that close minimum clearance from shrouds to volute is maintained. Both the end of the shaft and the bore of the impeller shall be tapered to permit easy removal of the impeller from the shaft.

ENGINEERING DATA



Smith &
Loveless, Inc.®

14040 West Santa Fe Trail Drive
Lenexa, Kansas 66215-1284

Series Wet Well
Mounted Pump Station
With 2 Non-Clog Series
Pump Sets Specification
Specification
May, 2012
Page 4

B. X-PELLER® SUPER CLOG RESISTANT MONO-PORT IMPELLER (OPTION)

The pump impeller shall be of the enclosed mono-port type made of close-grained cast-iron and shall be in dynamic balance when pumping wastewater. Two port impellers are specifically disallowed. The dynamic balance shall be obtained without the use of balance weights or liquid filled chambers. The impeller shall be designed to allow for the trimming of the impeller to meet design condition changes without altering the balance. The eye of the impeller as well as the port shall be large enough to permit the passage of a sphere 3" in diameter in accordance with nationally recognized codes. To further prevent clogging, the impeller port shall have a minimum area of 10.6 in². The impeller shall be keyed with a stainless steel key and secured to the motor shaft by a stainless steel capscrew equipped with a Nylock or other suitable self-locking device. The impeller shall not be screwed or pinned to the motor pump shaft and shall be readily removable without the use of special tools. To prevent the buildup of stringy materials, grit and other foreign particles around the pump shaft, all impellers less than full diameter shall be trimmed inside the impeller shrouds. The shrouds shall remain full diameter so that close minimum clearance from shrouds to volute is maintained. Both the end of the shaft and the bore of the impeller shall be tapered to permit easy removal of the impeller from the shaft.

MOTORS

The pump motors shall be vertical, solid shaft, NEMA P-base, squirrel-cage induction-type, suitable for _____ phase, _____ cycle, _____ volt electric current. They shall have Class F insulation, suitable for temperatures up to 105°C. The insulation temperature shall, however, be maintained below 80°C. The motors shall have normal starting torque and low-starting current, as specified by NEMA Design B characteristics. They shall be open drip-proof design with forced air circulation by integral fan. Openings for ventilation shall be uniformly spaced around the motor frame. Leads shall be terminated in a cast connection box and shall be clearly identified.

The motors shall have 1.15 service factor. The service factor shall be reserved for the owner's protection. The motors shall not be overloaded beyond their nameplate rating, at the design conditions, nor at any head in the operating range as specified under Operating Conditions.

The motor-pump shaft shall be centered, in relation to the motor base, within .005". The shaft runout shall not exceed .003".

The motor shaft shall equal or exceed the diameter specified under "main pump", at all points from immediately below the top bearing to the top of the impeller hub.

A bearing cap shall be provided to hold the bottom motor bearing in a fixed position. Bearing housings shall be provided with fittings for lubrication as well as purging old lubricant.

The motor shall be fitted with heavy lifting eyes or lugs, each capable of supporting the entire weight of the pump and motor.

[NOTE TO DESIGNER: CHOOSE FROM THE FOLLOWING MOTOR OPTIONS, IF REQUIRED. DELETE IF NOT REQUIRED]

A. SUPER DUTY MOTORS

The pump motors shall be Premium Efficiency type, per NEMA MG-1 table 12-12, Inverter Ready per NEMA Part 31.4.4.2, with cast-iron frames, and be UL Recognized and CSA Approved. The motor windings shall be 200 C Inverter Spike-Resistant magnet wire and the rotors shall have an epoxy coating for corrosion protection.

ENGINEERING DATA



Smith &
Loveless, Inc.®

14040 West Santa Fe Trail Drive
Lenexa, Kansas 66215-1284

Series Wet Well
Mounted Pump Station
With 2 Non-Clog Series
Pump Sets Specification
Specification
May, 2012
Page 5

B. IMMERSIBLE PUMP MOTORS

The pump motors shall be of special construction and fitted with special seals to enable the motor to be immersed in up to 30' of water for a period of up to three weeks, without water entering the motor cavity. As part of the immersible motor package, a float switch shall be provided in the station to provide indication of water approaching the level of the motors and another float switch shall shut down the motors when the water level reaches them. Each of these floats shall signal alarms and activate alarm lights on the control panel. The alarms shall remain activated until manually reset by switches on the panel. In addition, moisture detectors and high temperature thermostats shall be provided in each motor, as a backup, to shut down the associated pump and to signal alarm conditions and activate alarm lights on the control panel. All of these alarm contacts shall be wired to a terminal strip in the control panel for connection to the Owner's alarm system.

CONTROLS

The control equipment shall be mounted in a NEMA Type 1 steel enclosure. The circuit breakers and control switches shall be operable without opening the hinged access cover.

A grounding-type convenience outlet shall be provided on the side of the cabinet for operation of 115-Volt AC devices.

Thermal magnetic air circuit breakers shall be provided for branch disconnect service and short circuit protection of all motor control and auxiliary circuits.

Magnetic across-the-line starters with under-voltage release and overload coils for each phase shall be provided for each pump motor to give positive protection. Each single-phase auxiliary motor shall be equipped with an over-current protection device in addition to the branch circuit breaker, or shall be impedance protected. All switches shall be labeled and a coded wiring diagram shall be provided.

A time delay relay shall be provided to cause the second stage pump of each set to start and come up to speed before the first set is started. This is to prevent starting a pump with pressure on the seal.

[NOTE TO DESIGNER: SELECT ONE OF THE FOLLOWING LEVEL CONTROL SYSTEM PARAGRAPHS, A OR B, AND DELETE THE OTHER.]

A. FLOAT SWITCH LEVEL CONTROLS

To control the operation of the pumps with variations of liquid level in the wet well, a minimum of three (3) displacement switches shall be provided. A 30' cord shall be provided with each switch. The cord shall have a corrosion-resistant vinyl jacket and be multi-stranded in order to prevent fatigue.

An automatic alternator with manual switch shall be provided to change the sequence of operation of the pumps every eight hours. Alternating the pumps at less than eight-hour intervals will not be acceptable.

Provisions shall also be made for the pumps to operate in parallel should the level in the wet well continue to rise above the starting level for the low level pump.

B. PUMPLIGIX™ MICROPROCESSOR LEVEL CONTROL SYSTEM

The liquid level in the wet well shall be monitored by a submersible hydrostatic pressure transducer with stainless steel sensor diaphragm, providing a 4-20 mA signal to the pump control unit. The body of the transducer shall be made of 316 stainless steel. The pressure transducer shall have a permanent hermetically sealed connection to a polyethylene insulated cable, which shall support the transducer 6" from the bottom of the wet well, and shall pass through a cord grip seal in the station base. The pressure transducer unit shall be rated for wastewater or potable water service, and for operation in explosion hazardous areas.

ENGINEERING DATA



Smith &
Loveless, Inc.®

14040 West Santa Fe Trail Drive
Lenexa, Kansas 66215-1284

Series Wet Well
Mounted Pump Station
With 2 Non-Clog Series
Pump Sets Specification
Specification
May, 2012
Page 6

Three (3) displacement switches shall be provided to automatically operate the pump in back-up mode, in case of failure of the digital control system or the submersible level transducer. The back-up system shall be entirely independent of the digital system. A 30' color-coded cord shall be provided with each switch. The cord shall have a corrosion-resistant vinyl jacket and be multi-stranded in order to prevent fatigue. The displacement switch cords and the cable for the submersible pressure transducer shall enter the wet well through cord grip seals.

To control the operation of the pumps with variations of liquid level in the wet well, and the high and low water alarm functions, a specially preprogrammed, dedicated microprocessor-based control system shall be provided. The controller shall interface with the wet well level transducer, integral panel display unit, motor starters, and alarm functions as required.

The digital controls shall operate on 24 volts or less, to eliminate shock hazard. The 24-volt power supply shall be overload protected to be "crowbar safe" and will return to operation when a short is removed.

To reduce exposure to corrosive environments and ensure the control system's reliable, long-term operation, the controller shall have a sealed, user-friendly, graphical interface. The interface shall be comprised of a rotary knob, switches and five (5) columns of ultra-bright, daylight-viewable red LED's. Four (4) 40-segment, 4" columns of LED's shall show the wet well level, the pump on and off control bands, and the high and low alarm setpoint bands. All LED's within a control band shall be illuminated when operating under normal power. A fifth LED column shall indicate the controller's configuration, status and active alarms. Alarms shall consist of high alarm, low alarm and input signal out of range. Monitor functions shall include control power and normal system operation. Discrete LED's shall show the activation of the differential pump control stages.

The controller shall provide easy, convenient indication and adjustment of the operating setpoints and controller configuration without the need for tools. For ease of operation and configuration, multiple indicating columns are required. Controllers that provide fewer columns; thus, limiting the viewing of relevant and necessary station information, are specifically precluded by this specification.

The pump control circuits shall be forced OFF by power loss. Upon power restoration, the controller shall enable the pumps in an adjustable time-step sequence as required to meet the demand.

The controller shall continuously indicate the status of the selected alternation sequence and control modes. The controller shall provide 1st On/1st Off, Fixed and Auto Rotate alternation sequences.

Integral span, offset, and damping adjustments shall be easily adjustable. The controller shall have a configurable security lockout feature.

The controller shall contain a level simulation function that allows manual manipulation of the displayed process variable. While simulating, the controller shall display both the actual wet well level and the simulated level.

The controller shall contain an RS-232 communication port and have capabilities for connection to a SCADA (Supervisory Control and Data Acquisition) system using Modbus® protocol. The complete assembly shall be designed for use in UL508 Industrial Control Panels.

It is the specific intention of this functional requirement that a controller shall be provided with features as described herein. Additionally, this controller shall be a fully integrated assembly. That is, the furnishing of similar functions using multiple setpoint modules, a custom-configured programmable logic controller (PLC) or extensive relay/timer logic to accomplish control sequences, etc., is specifically precluded by this specification and is not acceptable.

ENGINEERING DATA



Smith &
Loveless, Inc.®

14040 West Santa Fe Trail Drive
Lenexa, Kansas 66215-1284

Series Wet Well
Mounted Pump Station
With 2 Non-Clog Series
Pump Sets Specification
Specification
May, 2012
Page 7

HIGH WET WELL LEVEL ALARM

An adjustable mercury displacement switch shall be provided to sense a high water level condition. The switch shall hang into the wet well and shall activate a contact to indicate the high water condition.

RUNNING TIME METER

A running time meter shall be supplied for each pump to show the number of hours of operation. The meter shall be enclosed in a dust and moisture-proof molded plastic case. The flush-mounted dial shall register in hours and tenths of hours up to 99,999.9 hours before repeating. The meter shall be suitable for operation from a 115-volt, 60-cycle supply.

PUMP FAILURE TO PRIME OR FAILURE TO PUMP ALARM (CHECK VALVE SWITCH TYPE)

To sense failure to deliver normal flow for any reason, including failure to prime, each pump shall be provided with a sealed sensor switch mounted in a protective ABS enclosure. The enclosure shall be mounted with an adjustable universal mounting bracket to the external arm of each discharge check valve. The mounting bracket shall allow the adjustment of the sensor switch with a single locking pivot adjustment. A red LED indicating light shall be provided on each switch unit to facilitate accurate setting of the switch for proper operation. The sensor switch shall monitor the movement of the check valve arm and thereby detect failure of the pump to deliver normal operating flow when called on to run. An auxiliary time delay relay shall be provided to prevent an alarm signal during the pump priming and startup period.

VACUUM-PRIMING SYSTEM

A vacuum priming system shall be furnished to prime the main pumps. The system shall be as shown on the vacuum priming schematic and shall include two (2) vacuum pumps, providing 100 percent standby. Vacuum pumps shall have corrosion-resistant internal components. The vacuum priming system shall be complete with large port vacuum control solenoid valves, **SONIC START**® prime level sensor, float-operated check valves to protect the vacuum pumps, and all necessary shut-off valves as shown on the piping schematic. The float-operated check valves shall have a transparent body for visual inspection. All hoses and tubing used in the priming system shall be at least 3/8" nominal diameter.

The solenoid valves used in the vacuum priming system shall be of the high flow, direct acting brass body type, with threaded ports, NBR seals and 300 Series stainless steel plunger, rod, plate and springs. The minimum orifice diameter shall be 5/16". The solenoid valves shall be UL Listed, with Class F coil rating and of suitable voltage and thermal capacity for the application.

Liquid level in the pump priming chamber shall be monitored by a **SONIC START**® resonant frequency liquid level probe. The probe shall be equipped with a piezoelectric drive and sensitive circuits to detect frequency shifts when the probe is covered by liquid. The probe shall be completely sealed and have a 316L stainless steel housing for corrosion resistance. It shall be provided with a wiring connector molded of PolyPhenylSulfone, an amorphous high performance thermoplastic for impact and chemical resistance. The probe shall have a plug-in connector to facilitate easy removal.

The **SONIC START**® probe shall be provided with light emitting diodes. This diagnostic tool shall indicate connectivity, prime status or a fault condition. Systems utilizing an electrode, mechanical means such as a float, or that require any type of electrical or moving parts inside the priming chamber, which may accumulate debris, short out, bind or fail will not be acceptable.

The priming system shall automatically provide positive lubrication of the mechanical seal each time a main pump is primed. To prevent excessive stoppage due to grease accumulation, no passageway in the priming system through which the pumped liquid must pass shall be smaller than the equivalent of a 2-1/2" opening.

ENGINEERING DATA



Smith &
Loveless, Inc.®

14040 West Santa Fe Trail Drive
Lenexa, Kansas 66215-1284

Series Wet Well
Mounted Pump Station
With 2 Non-Clog Series
Pump Sets Specification
Specification
May, 2012
Page 8

The vacuum priming system shall have two field selectable modes of operation. In the "On-Demand" mode, the priming system will operate only after a pump is called on to run, and if it is not primed. Once primed, the pump will be allowed to run. In the "Constant Prime" mode, both pumps are kept primed continuously, and ready to start immediately when called for.

(OPTIONAL ITEM – CHECK IF REQUIRED)

SINGLE-PHASE 120-VOLT POWER TRANSFORMER [DESIGNER: A STATION MOUNTED CONTROL POWER TRANSFORMER IS REQUIRED FOR ALL STATIONS UNLESS A SEPARATE 1/60/120 SUPPLY FROM A SEPARATE TRANSFORMER (NOT A PHASE-TO-NEUTRAL TAP FROM THE 3-PHASE SUPPLY) IS AVAILABLE. SELECT FROM FOLLOWING CHART:]

<u>SUCTION PIPE SIZE</u>	<u>AUX. HEATER</u>	<u>MIN. TRANSFORMER SIZE</u>
4"	NO	3 KVA 208/230/460V
4"	YES	5 KVA 208/230/460V
6" OR 8"	NO	5 KVA 208/203/460V
6" OR 8"	YES	7.5 KVA 208/230/460V

A (3) (5) (7.5) KVA insulating-type transformer shall be provided to supply power for lights, controls and auxiliary devices. The transformer shall have 240/480 volt primary, 120/240 volt secondary, Class F insulation, with temperature rise not to exceed 115°C above 40°C ambient. The core and coil assembly shall be given a double dip and bake. The coil shall be protected by a metal housing to prevent damage. The transformer shall be protected by a separate circuit breaker on the supply side.

ENVIRONMENTAL EQUIPMENT

A ventilating blower shall be provided, capable of delivering 650 cfm at 0.1" static water pressure, in order to remove the heat generated by continuous motor operation. The ventilating blower shall be turned on and off automatically by a preset thermostat. A louvered opening shall cover the discharge. A 500-watt electric heater controlled by a preset thermostat shall be furnished. The heater shall be rigidly mounted in the station to prevent removal.

MAIN PIPING

The first stage pump suction shall be drilled and tapped for a 125-pound American Standard flange for ready connection of the suction riser. The discharge line from each first stage pump shall be fitted with a flanged outlet connected to the suction flange of the corresponding second stage pump. The discharge line from each second stage pump shall be connected to a clapper-type check valve and eccentric plug valve. Size, location and quantity of check valves and plug valves shall be as shown on the drawings. The check valve shall be of the spring-loaded type with external lever arm and an easily replaced resilient seat for added assurance against vacuum leaks. Check valves shall have stainless steel shaft with replaceable bronze shaft bushings and shall be sealed with an adjustable Teflon seal. An operating wrench shall be provided for the plug valves.

Protrusions through the floor plate shall be gas-tight where necessary to effect sealing between the equipment chamber and the wet well. The pump station manufacturer shall extend the suction and discharge connections below the floor plate at the factory, so that field connections can be made without disturbing the gas-tight seals.

The manufacturer of the pump station shall provide a compression-type sleeve coupling for installation in the common discharge pipe. Provisions shall also be made for tying the coupling to the station floor plate.

ENGINEERING DATA



Smith &
Loveless, Inc.®

14040 West Santa Fe Trail Drive
Lenexa, Kansas 66215-1284

Series Wet Well
Mounted Pump Station
With 2 Non-Clog Series
Pump Sets Specification
Specification
May, 2012
Page 9

The attached pump specification and checklist must be met in total. There are many reasons for incorporating a good pump specification. For example, the stainless steel shaft with tapered impeller attachment is provided to minimize corrosion, extend seal life and provide ease of impeller removal and seal replacement without the use of a wheel puller.

All items specified are for long life, durability and maintainability of the pumping equipment. Deviations from the pump specifications will not be allowed.

A checklist is also provided to insure that the proper pumping system is provided to the owner.

FACTORY TESTS

All components of the pump station shall be given an operational test at the pump station manufacturers facility to check for excessive vibration, for leaks in the piping or seals and correct operation of the automatic control and vacuum priming systems and all auxiliary equipment. Installed pumps shall take suction from a deep wet well, simulating actual service conditions. The control panel shall undergo both a dry logic test and a full operational test with all systems operating.

Factory test instrumentation must include flow measuring with indicator; compound suction gauge; Bourdon tube-type discharge pressure gauge; electrical meters to measure amperes, volts, kilowatts and power factor; speed indicator and a vibrometer capable of measuring both amplitude and frequency.

SPARE PARTS

A complete replacement pump shaft seal assembly shall be furnished with each pump station. The spare seal shall be packed in a suitable container and shall include complete installation instructions. A spare volute gasket and seal gasket shall be provided.

An instructional video presentation on the pump mechanical seal system in DVD format shall be included. The DVD shall contain a presentation on the following subjects: purpose and location of the mechanical seal, signs of a defective mechanical seal, how to remove the mechanical seal, troubleshooting seal failure causes, seal components, required tools, how to reinstall the seal, and how to place the pump back into service. The video shall include footage of an actual seal replacement.

INSTALLATION AND OPERATING INSTRUCTIONS

Installation of the pump chamber shall be done in accordance with the written instructions provided by the manufacturer.

Operation and maintenance manuals shall be furnished which will include parts lists of components and complete service procedures and troubleshooting guide.

STARTUP

The Manufacturer shall provide the services of a factory-trained representative for a maximum period of one day on-site to perform initial startup of the pump station and to instruct the owner's operating personnel in the operation and maintenance of the equipment.

WARRANTY

The manufacturer of the station shall warrant for one (1) year from date of start-up, not to exceed (18) eighteen months from date of shipment, that the structure and all equipment he provides will be free from defects in material and workmanship. Warranties and guarantees of the suppliers of various components in lieu of a single source responsibility by the Manufacturer will not be accepted. The Manufacturer shall assume prime responsibility for the warranty of the station and all components.

ENGINEERING DATA



Smith &
Loveless, Inc.®

14040 West Santa Fe Trail Drive
Lenexa, Kansas 66215-1284

Series Wet Well
Mounted Pump Station
With 2 Non-Clog Series
Pump Sets Specification
Specification
May, 2012
Page 10

In the event a component fails to perform as specified or is proven defective in service during the warranty period, the Manufacturer shall repair or replace, at his discretion, such defective part. He shall further provide, without cost, such labor as may be required to replace, repair or modify major components such as the steel structure, main pumps, main pump motors and main piping manifold. After start-up service has been performed, the labor to replace accessory items, such as the blower, priming pumps, alternator, etc., shall be the responsibility of others.

The repair or replacement of those items normally consumed in service, such as seals, grease, light bulbs, etc., shall be considered as part of routine maintenance and upkeep.

It is not intended that the Manufacturer assume responsibility for contingent liabilities or consequential damages of any nature resulting from defects in design, material, workmanship or delays in delivery, replacement or otherwise.

MANUFACTURER'S INSURANCE

All equipment manufacturers, either direct or subcontractors to the general or mechanical contractors, SHALL HAVE in effect at TIME OF BID, CONTRACT AWARD, CONTRACT PERFORMANCE, and WARRANTY TERM, PRODUCT AND COMPREHENSIVE LIABILITY INSURANCE, INCLUDING SUDDEN AND ACCIDENTAL POLLUTION COVERAGE in the amount of FIVE MILLION DOLLARS, \$5,000,000 through an insurance company with a minimum rating of A+ (SUPERIOR) XV according to the BEST'S INSURANCE REPORTS. All policies must be written on an OCCURRENCE BASIS. Policies written on a CLAIMS MADE BASIS are not acceptable. A typical CERTIFICATE OF INSURANCE attesting to the specified coverage issued by the responsible carrier naming the ENGINEER OF RECORD and the OWNER as ADDITIONAL INSURED, must be presented to the named additional insured prior to contract award. A FAILURE TO COMPLY with this requirement BY THE BIDDER will require DISQUALIFICATION of the BID and CONTRACT AWARD.

MANUFACTURED EQUIPMENT

OPTION 1 (STANDARDIZATION) [DELETE THIS LINE FROM FINAL SPEC TEXT]

The specifications and drawings detail Smith & Loveless equipment and represent the minimum standard of quality for both equipment and materials of construction. The contractor shall prepare his bid on the basis of the particular equipment and materials specified for the purpose of determining the low bid.

The owner has standardized on the named equipment in order to optimize their operation, maintenance and safety programs, provide for interchangeability of costly equipment items, reduce stocking levels required for necessary spare parts and provide increased flexibility in the utilization of their pumping stations. Equipment substitutions, since incompatible with the districts standardization program, will not be considered.

OPTION 2

(BASE BID WITH BID SUBMITTAL) [DELETE THIS LINE FROM FINAL SPEC]

The specifications and drawings detail Smith & Loveless equipment and represent the minimum standard of quality for both equipment and materials of construction. The contractor shall prepare his bid on the basis of this equipment for the purpose of determining the low bid without consideration of a possible substitute.

BID SUBMITTAL (APPLICABLE TO OPTION 2)

This submittal shall include all necessary information for the proper determination of the acceptability of the proposed substitution and shall not necessarily be limited to the following.

- A. Complete description of the equipment, system, process, or function, including a list of system components and features, drawings, catalog information and cuts, manufacturer's specifications, including materials description.
- B. Performance data and curves, and horsepower requirements.
- C. Outside utility requirements, such as water, power, air, etc.

ENGINEERING DATA



Smith &
Loveless, Inc.®

14040 West Santa Fe Trail Drive
Lenexa, Kansas 66215-1284

Series Wet Well
Mounted Pump Station
With 2 Non-Clog Series
Pump Sets Specification
Specification
May, 2012
Page 11

- D. Functional description of any internal instrumentation and control supplied including list of parameters monitored, controlled or alarmed.
- E. Addresses and phone numbers of nearest service centers and a listing of the manufacturers or manufacturer's representatives services available at these locations, including addresses and phone numbers of the nearest parts warehouses capable of providing full parts replacement and/or repair services.
- F. A list of five (5) installations in the states where similar equipment by the manufacturer is currently in similar service; include contact name, telephone number, telephone number, mailing address of the municipality or installation, engineer, owner and installation contractor; if five installations do not exist, the list shall include all that do exist, if any.
- G. Detailed information on site, architectural, structural, mechanical, plumbing, electrical, and control and all other changes or modifications to the design and construction work necessary to adapt the equipment or systems to the arrangement shown and/or functions described on the drawings and in the technical specifications. This shall include plan view and section sketches illustrating any additional space requirements necessary to provide the minimum adequate clear space within and around the equipment for operation and maintenance, as shown on the Drawings and specified.
- H. All differences between the specifications and the proposed substitute equipment shall be clearly stated in writing under a heading of "differences".
- I. Other specific submittal requirements listed in the detailed equipment and material specifications.
- J. A completed and signed copy of the "Pump Station Certification Affidavit" which follows.

EVALUATION

Approval of the substitution to bid as an alternate shall in no way relieve the contractor from submitting the specified shop drawings for approval or complying fully with all provisions of the specifications and drawings.

If substituted equipment is accepted, the contractor shall, at his own expense, make any changes in the structures, piping, electrical, etc. necessary to accommodate the equipment. If engineering is required due to substitution of alternate equipment, the contractor shall pay for all engineering charges.

To receive final consideration, copies of the manufacturers' quotations for the equipment may be required to document the savings to the satisfaction of the engineer. It is the intent that the owner shall receive the full benefit of the savings in cost of equipment and the contractor's bid price shall be reduced by an amount equal to the savings. In all technical and other evaluations, the decision of the engineer is final.

TYPICAL BID FORM

[ADD TO BID FORM AS APPLICABLE TO ABOVE SELECTED OPTION]

OPTION 1

For reasons of standardization, bids shall be based on the named equipment. Alternate bids will not be allowed.

OPTION 2

The bid shall be based on the named equipment. Alternate/substitute equipment may be offered as a deduct, provided all conditions of the "manufactured equipment" section are met.

Alternate/substitute manufacturer _____

Deduct \$ _____.

ENGINEERING DATA



Smith &
Loveless, Inc.®

14040 West Santa Fe Trail Drive
Lenexa, Kansas 66215-1284

Series Wet Well
Mounted Pump Station
With 2 Non-Clog Series
Pump Sets Specification
Specification
May, 2012
Page 12

PUMP STATION CERTIFICATION AFFIDAVIT

(Two-Port Impeller)

A submittal to the owner by manufacturers proposing alternate, unnamed pump stations will be required with their bid. Included in the submittal shall be detailed drawings and specifications on the proposed pump station. The bid submittal shall include the following completed checklist signed by an officer of the company.

	YES	NO
Close-coupled pump design - no motor to pump shaft coupling		
Pump shaft diameter of _____ minimum through seal		
Full diameter impeller shrouds		
Stainless steel pump shaft with tapered shaft to impeller fit		
Maximum pump shaft overhang of 6"- lower bearing to impeller		
Bronze seal housing		
Minimum pump efficiency at design point of _____ GPM of _____ %		
Impeller eye and ports pass a 3" sphere		
Class F motor insulation with Class B max motor temperature rise and 1.15 service factor		
Motor shaft run-out 0.003" max at end of shaft		
Motor shaft centered to motor base with 0.005"		
Locked lower bearing and floating upper bearing		
One-piece motor adapter/backhead		
Motor HP of _____ at _____ RPM		
Complete pump station factory tested on a wet well		
Priming from low pressure area behind the impeller		
Resonant frequency pump prime detection system		
Transparent priming bowl for operator monitoring		
Hollow priming adapter for positive seal lubrication		
Completely separate priming system for each pump		
Minimum 2-1/2" equivalent opening in priming passageways		
Maximum 20 lb. Force required to open station cover		
All other items for the station, as specified with minimum sizes, capacities and materials indicated		
Product liability insurance, \$5 million per specification		
Structure blasted with steel grit in environmentally controlled booth prior to coating with epoxy resin		

The consulting engineer shall be the sole judge of whether the proposed equipment is acceptable. The manufacturer shall have the responsibility of submitting sufficient information in one submission. Incomplete or inaccurate submittal data shall be cause for rejection of the proposed equipment.

By signing this affidavit, the officer of the company has stated 100% compliance with the plans and specifications and further states he will supply or pay for all deficiencies found in the job submittals or after the unit is installed. The consulting engineer shall be the sole judge regarding compliance with the plans and specifications and shall be sole judge on the amount of moneys required if any deficiencies are found, related to, but not limited to, a 20-year station design life.

Signature of Company Officer

Corporate Seal
(Notarized)

Title

ENGINEERING DATA



Smith &
Loveless, Inc.®

14040 West Santa Fe Trail Drive
Lenexa, Kansas 66215-1284

Series Wet Well
Mounted Pump Station
With 2 Non-Clog Series
Pump Sets Specification
Specification
May, 2012
Page 13

PUMP STATION CERTIFICATION AFFIDAVIT

(X-PELLER® Mono-Port Impeller)

A submittal to the owner by manufacturers proposing alternate, unnamed pump stations will be required with their bid. Included in the submittal shall be detailed drawings and specifications on the proposed pump station. The bid submittal shall include the following completed checklist signed by an officer of the company.

	YES	NO
Close-coupled pump design - no motor to pump shaft coupling		
Pump shaft diameter of _____ minimum through seal		
Full diameter impeller shrouds		
Stainless steel pump shaft with tapered shaft to impeller fit		
Maximum pump shaft overhang of 6"- lower bearing to impeller		
Bronze seal housing		
Minimum pump efficiency at design point of _____ GPM of _____ %		
Impeller eye and port pass a 3" sphere		
Impeller of mono-port design with a minimum area of 10.6 square inches		
Trimming of impeller vane does not alter dynamic balance		
Impeller dynamically balanced without use of weights or liquid filled chambers		
Class F motor insulation with Class B max motor temperature rise and 1.15 service factor		
Motor shaft centered to motor base with 0.005" with shaft run-out 0.003" max at end of shaft		
Locked lower bearing and floating upper bearing		
One-piece motor adapter/backhead		
Motor HP of _____ at _____ RPM		
Complete pump station factory tested on a wet well		
Priming from low pressure area behind the impeller		
Resonant frequency pump prime detection system		
Transparent priming bowl for operator monitoring		
Hollow priming adapter for positive seal lubrication		
Completely separate priming system for each pump		
Minimum 2-1/2" equivalent opening in priming passageways		
Maximum 20 lb. Force required to open station cover		
All other items for the station, as specified with minimum sizes, capacities and materials indicated		
Product liability insurance, \$5 million per specification		
Structure blasted with steel grit in environmentally controlled booth prior to coating with epoxy resin		

The consulting engineer shall be the sole judge of whether the proposed equipment is acceptable. The manufacturer shall have the responsibility of submitting sufficient information in one submission. Incomplete or inaccurate submittal data shall be cause for rejection of the proposed equipment.

By signing this affidavit, the officer of the company has stated 100% compliance with the plans and specifications and further states he will supply or pay for all deficiencies found in the job submittals or after the unit is installed. The consulting engineer shall be the sole judge regarding compliance with the plans and specifications and shall be sole judge on the amount of moneys required if any deficiencies are found, related to, but not limited to, a 20-year station design life.

Signature of Company Officer

Corporate Seal
(Notarized)

Title

ENGINEERING DATA



Smith &
Loveless, Inc.®

14040 West Santa Fe Trail Drive
Lenexa, Kansas 66215-1284

Series Wet Well
Mounted Pump Station
With 2 Non-Clog Series
Pump Sets Specification
Specification
May, 2012
Page 14

ADDITIONAL ACCESSORY OPTIONS [DESIGNER: SELECT AS REQUIRED]

LOW WET WELL LEVEL ALARM

An adjustable displacement switch shall be provided to sense a low water level condition. The switch shall hang into the wet well and shall activate a contact to indicate the low water condition.

RUNNING TIME METER FOR PARALLEL OPERATION

A third running time meter shall be supplied to show the number of hours of operation with both pump sets running in parallel. The meter shall be enclosed in a dust and moisture-proof molded plastic case. The flush mounted dial shall register in hours and tenths of hours up to 99,999.9 hours before repeating. The meter shall be suitable for operation from a 115-volt, 60-cycle supply.

PUMP RUNNING LIGHTS

A green panel light to indicate "Pump On" shall be provided for each main pump.

120V Alarm Light

A vapor-proof light fixture with 50-watt lamp for outdoor pole mounting shall be provided with a red globe and guard.

120V Alarm Light with Flasher

A vapor-proof light fixture with 50-watt flashing lamp for outdoor pole mounting shall be provided. The light shall flash during alarm conditions. The fixture shall be complete with a red globe and guard.

120V Alarm Bell

A vibratone-type bell mounted on a weather-tight box suitable for pole mounting shall be provided.

120V Alarm Horn

A vibratone-type horn mounted on a weather-tight box suitable for pole mounting shall be provided.

12V Trickle Charger

Storage batteries and charger shall be supplied to furnish power for operating alarm annunciators in cases of power failure. The storage batteries (two 3-cell, 6-volt) shall be maintenance-free lead-calcium battery concealed in high impact, heat-resistant and permanently sealed containers. The battery charger shall be solid-state, capable of restoring battery to full charge within 12 hours after a discharge, not exceeding 1.5 hours. Brownout protection is standard, and will activate the unit when AC line voltage drops below 85 volts.

12V Alarm Light

A vapor-proof light fixture with 50-watt lamp for outdoor pole mounting shall be provided with a red globe and guard.

12V Alarm Bell

A vibratone-type bell mounted on a weather-tight box suitable for pole mounting shall be provided.

12V Alarm Horn

A vibratone-type horn mounted on a weather-tight box suitable for pole mounting shall be provided.

Panel Mounted Automatic Reset Alarm Silence Switch

A momentary contact alarm silencing switch mounted on the control panel shall be provided. The alarm shall automatically be reset when the alarm condition is removed.

ENGINEERING DATA



Smith &
Loveless, Inc.®

14040 West Santa Fe Trail Drive
Lenexa, Kansas 66215-1284

Series Wet Well
Mounted Pump Station
With 2 Non-Clog Series
Pump Sets Specification
Specification
May, 2012
Page 15

Remote Mounted Automatic Reset Alarm Silence Switch

A momentary contact alarm silencing switch mounted in a weatherproof box suitable for pole mounting shall be provided. The alarm shall automatically be reset when the alarm condition is removed.

Remote Alarm Contacts

In addition to the common, powered local alarm connection, individual unpowered contacts shall be provided and wired to a terminal strip for field connection to a remote alarm monitoring system (not included).

Alarm Dialer Interface (Dialer Not Included)

Provisions shall be made within the pump station to facilitate the field installation of an alarm dialer, which is to be furnished and installed by others. The alarm dialer shall be as described elsewhere in these specifications. The factory built pump station shall be provided with a mounting bracket approximately 12 inches by 10-5/8 inches to attach and support the alarm dialer, near the station control panel, beneath the fiberglass enclosure. In addition, openings for conduit connections shall be provided in the bottom of the station control panel and through the side of the station base, to facilitate wiring of the alarm dialer input, output and power connections. In addition to the powered common local alarm contact, the station control panel shall have terminal strip connections for fault-opening alarm contacts to provide discrete alarm input signals to the dialer and shall also include terminal strip connections for a 1/60/120 volt power source, on a separate 15-amp circuit, to power the dialer. Wiring of the dialer shall be done by others during installation of the station in the field.

BASE1-BASE2-AUTO ALTERNATE SELECTOR SWITCH

A 3-position selector switch shall be mounted on the face of the control panel to allow selection of either pump set as the lead pump, or to allow for automatic alternation.

Surge Protective Device

A surge protective device for lightning and surge protection with an internal automatic discharge circuit and rated for three phase service shall be provided.

Time Delay

The pump control system shall provide for a time delay to prevent simultaneously starting the pump motors after power failure.

Sequential Alternation

In lieu of the timed alternation system, provisions shall be made to alternate the pump sets at the completion of each pumping cycle.

Generator Interlock

Provisions shall be made in the control circuit of the lift station to facilitate locking out the standby pump set when the emergency generator set is powering the station. An interlock consisting of a normally closed auxiliary contact shall be supplied with the emergency generator controls by the generator manufacturer. This normally closed contact shall be wired to the terminal blocks provided in the lift station control panel by the lift station manufacturer. The interconnecting wiring shall be supplied and connected by the installing contractor.

Add-A-Phase Interface

Terminals shall be provided in the lift station control panel to facilitate connection to an external Add-A-Phase phase converter unit.

Roto Phase Interface

Terminals and a time delay to prevent simultaneously starting the pump motors after power failure shall be provided in the lift station control panel to facilitate connection to an external Roto Phase phase converter unit.

ENGINEERING DATA



Smith &
Loveless, Inc.®

14040 West Santa Fe Trail Drive
Lenexa, Kansas 66215-1284

Series Wet Well
Mounted Pump Station
With 2 Non-Clog Series
Pump Sets Specification
Specification
May, 2012
Page 16

Intrinsically Safe Control

Intrinsically safe relays to provide low current isolated switching for the float switches shall be provided.

Main Circuit Breaker

A main circuit breaker shall be installed in the control panel to provide over-current protection for the station, and shall be capable of being used to disconnect the three-phase power to the pump station. The breaker shall be operable without opening the panel, and shall be interlocked with the panel door. It shall be capable of being padlocked in the "Off" position.

Solid-State Reduced Voltage Starters

UL listed, solid-state reduced voltage starters shall be supplied. The starters shall be capable of a soft start and soft stop. The starters shall have built in overload protection as well as built in bypass contactors. One set of form C auxiliary contacts shall be supplied on the starter. The starters shall be powered by 24V DC and shall have a built-in Digital Signal Processor utilizing a low impedance run circuit. The starters shall be easily programmable by using a standard screwdriver.

Phase Monitor

A relay with double pole, double throw contacts shall be provided to monitor and protect against phase loss (single-phasing), under voltage (brownouts) and phase reversal (improper sequence). It shall automatically reset when three-phase service returns to normal.

Single-Phase Power Monitor

A relay shall be provided to monitor the 120-Volt single-phase control power supply and initiate an alarm on loss of power. It shall automatically reset when the single-phase service returns to normal.

Pump Prime Failure

A time delay relay shall be connected to each vacuum pump. Contacts shall be provided to automatically shut down the operating vacuum pump, allow starting of the next pump in the operating sequence and signal an alarm on excessive vacuum pump operating time. Contacts shall be provided for transmitting an alarm signal.

Operator Assist Alarm

The station control panel shall be provided with a maintained contact, manually operated, red mushroom-head Operator Assist Alarm Button in an easily accessible position on the control panel to signal emergency operator assistance is required. It also may be used to provide means for testing the alarm system.

Unauthorized Entry Alarm

A timer circuit shall be provided in the control panel to signal unauthorized entry into the pump station. The timer shall be activated whenever the fiberglass cover is opened. A key operated switch shall be provided on the station control panel to provide authorized personnel a means to deactivate the alarm before the timer completes its cycle.

NEMA Starters

NEMA rated magnetic across-the-line starters with overload protection for each phase shall be provided for each pump motor to give positive protection against phase unbalance, thermal overload, phase loss and ground fault.

Auxiliary Station Heater

A 1300/1500 watt, dual range, electric heater with automatic circulating fan, thermostat control and an On/Off switch is to be provided. The heater is to be operated by connection to the station convenience receptacle.

Insulated Hood

The fiberglass cover shall have a minimum of 1" thick urethane insulation, protected by fiberglass, with an "R" value of 7 or more.

ENGINEERING DATA



Smith &
Loveless, Inc.®

14040 West Santa Fe Trail Drive
Lenexa, Kansas 66215-1284

Series Wet Well
Mounted Pump Station
With 2 Non-Clog Series
Pump Sets Specification
Specification
May, 2012
Page 17

Certified Curves

Factory-certified performance test curves shall be provided for the pumps, tested after installation in the station, to simulate actual operating conditions. Copies of these curves, showing head, flow, BHP, efficiency and the backup data, shall be provided with the station. Typical data or curves from a similar pump are not acceptable. Data and curves must be for the actual pumps provided, and while mounted in the station.

Wet Well Blower

A ventilating blower capable of delivering 100 CFM shall be provided for ventilation of the wet well. The wet well blower shall be enclosed in a NEMA 3R rain-tight cabinet with a louvered cover and shall be mounted on the station base adjacent to the manway access hatch. A manual switch on the control panel shall operate the blower.

Remove Fiberglass Enclosure

The fiberglass enclosure, station ventilating blower and 500-Watt electric heater shall not be provided.

Remove Manway Access Cover

The aluminum treadplate manway access cover, stainless steel piano hinge and hardware shall not be provided.

Protected Liquid Filled Compound Pressure Gauges

A four-inch (4") Bourdon tube type compound vacuum/pressure gauge with 3-1/2" dial, fitted with a brass stop valve and a manual air relief valve shall be provided for each pump set. The gauges shall be mounted apart from the pumps, on a bracket attached to the control panel support structure, and connected to the second stage pump discharge taps by flexible tubing, to minimize vibration. The range of each gauge shall be selected to place the normal operating discharge pressure reading in the middle one-third of the scale and the gauge shall also be capable of measuring up to 30" HG of vacuum. The dial shall be white with black markings and the gauge itself shall have an accuracy of 1% of scale. The gauge shall be American made, with a Zytel Nylon case with 1/2" blowout plug, stainless steel bezel, acrylic lens and phosphorus bronze tube with brass socket. Each compound gauge shall be filled with a viscous fluid to dampen vibration and pulsation effects on the needle reading. Temperature compensation shall be provided by an internal compensating diaphragm. Gauges shall be protected from the service fluid by a Buna-N elastomer "boot" diaphragm within the stem, and the Bourdon tube and the space between the Bourdon tube and the internal isolating diaphragm shall be filled with low temperature instrument oil, completely isolating the gauge components from the fluid being measured.

Emergency Pumping Connection

The common discharge pipe of the pump station shall be fitted with a branch with a plug valve and male quick-connect fitting with cap, as shown on the drawings, to facilitate connection of a portable emergency pump to the force main, to bypass the pump station. The emergency pumping connection shall be housed within the fiberglass cover.

Toolkit

A metal toolbox complete with the following tools shall be provided. This complement of tools shall include all tools necessary to replace the pump mechanical seal.

9/16" x 1/2" Box End Wrench

3/4" x 5/8" Open End Wrench

15/16" x 1" Open End Wrench

1-1/8" Socket

8" T-Handle 11" x 1/2" Drive

1/2" x 5-1/2" Drive Extension

6" Pipe Wrench

#3 Rawhide Mallet

Ratchet-Type Hoist

Motor Lifting Bar

ENGINEERING DATA



Smith &
Loveless, Inc.®

14040 West Santa Fe Trail Drive
Lenexa, Kansas 66215-1284

Series Wet Well
Mounted Pump Station
With 2 Non-Clog Series
Pump Sets Specification
Specification
May, 2012
Page 18

Lint-Free Cloth
Multi-Purpose Grease

Additional Spare Mechanical Seals

In addition to the one standard spare mechanical seal, _____ additional spare mechanical seal(s) shall be provided. The spare seal(s) shall be packed in a suitable container and shall include complete installation instructions.

Test Unit With Battery For Multi-Sensor Check Valve Switch [For Use With Relay Logic Controls. Not Required With PROTRONIX® II or PUMPLOGIX™ Controllers]

To test or set the multi-sensor check valve switches, using the built-in LED light, with Relay Logic control systems, a separate, hand held battery pack, with connecting cord and plug, shall be provided. This is to enable the operator to accurately set the trip point of the switch manually, by means of the built-in test light on the multi-sensor.

ENGINEERING DATA



Smith & Loveless, Inc.®

14040 West Santa Fe Trail Drive
Lenexa, Kansas 66215-1284

Series Recessed Wet Well Mounted Pump Station
Outline Drawing 87C335
4B2B / 4B2D / 4C2B / 4C2D
4" Piping
May, 2012

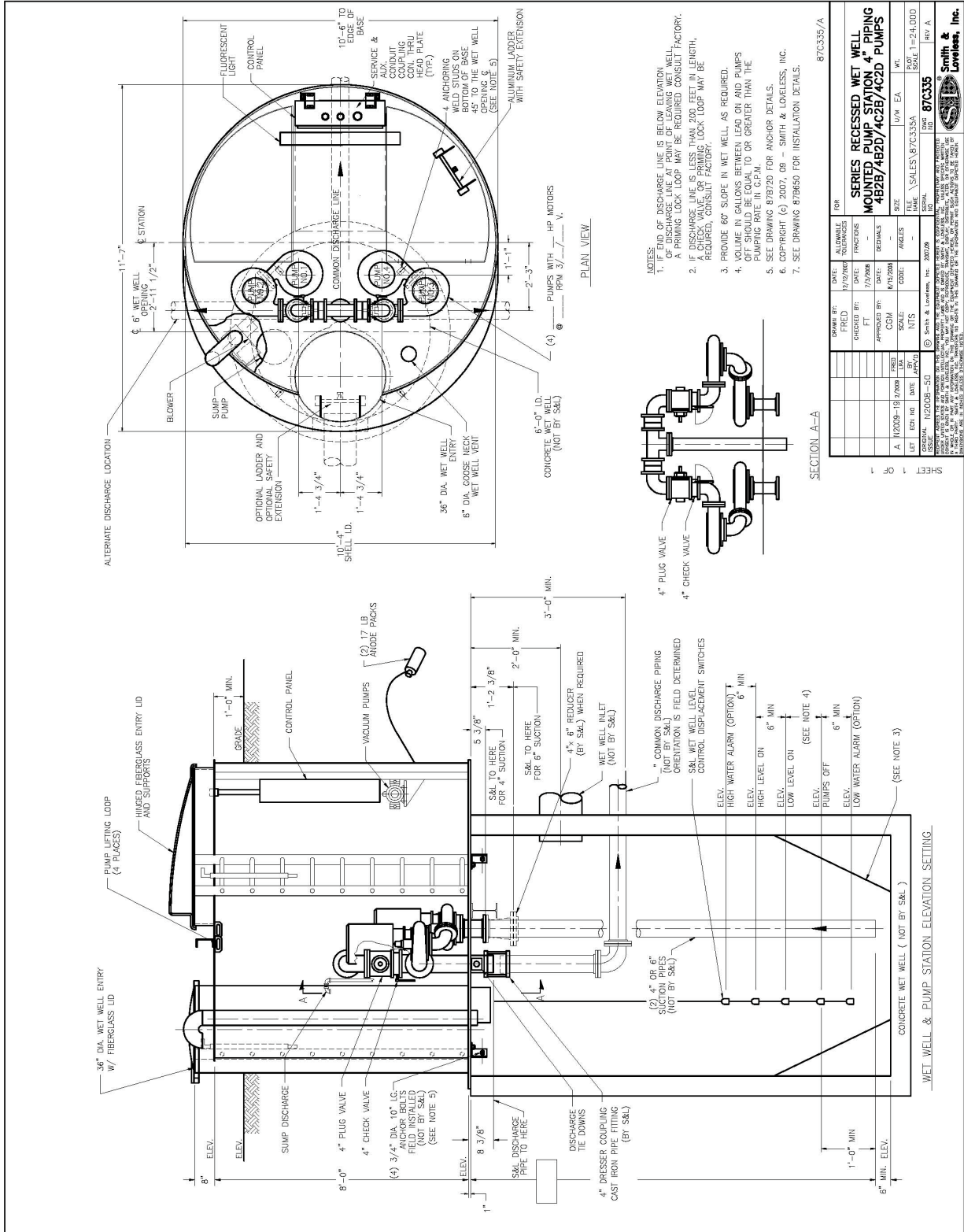

ENGINEERING DATA



Smith &
Loveless, Inc.®

14040 West Santa Fe Trail Drive
Lenexa, Kansas 66215-1284

Series Recessed Wet Well
Mounted Pump Station
Outline Drawing 87C338
4B3B / 4C3D / 4D3B
6" Piping
May, 2012

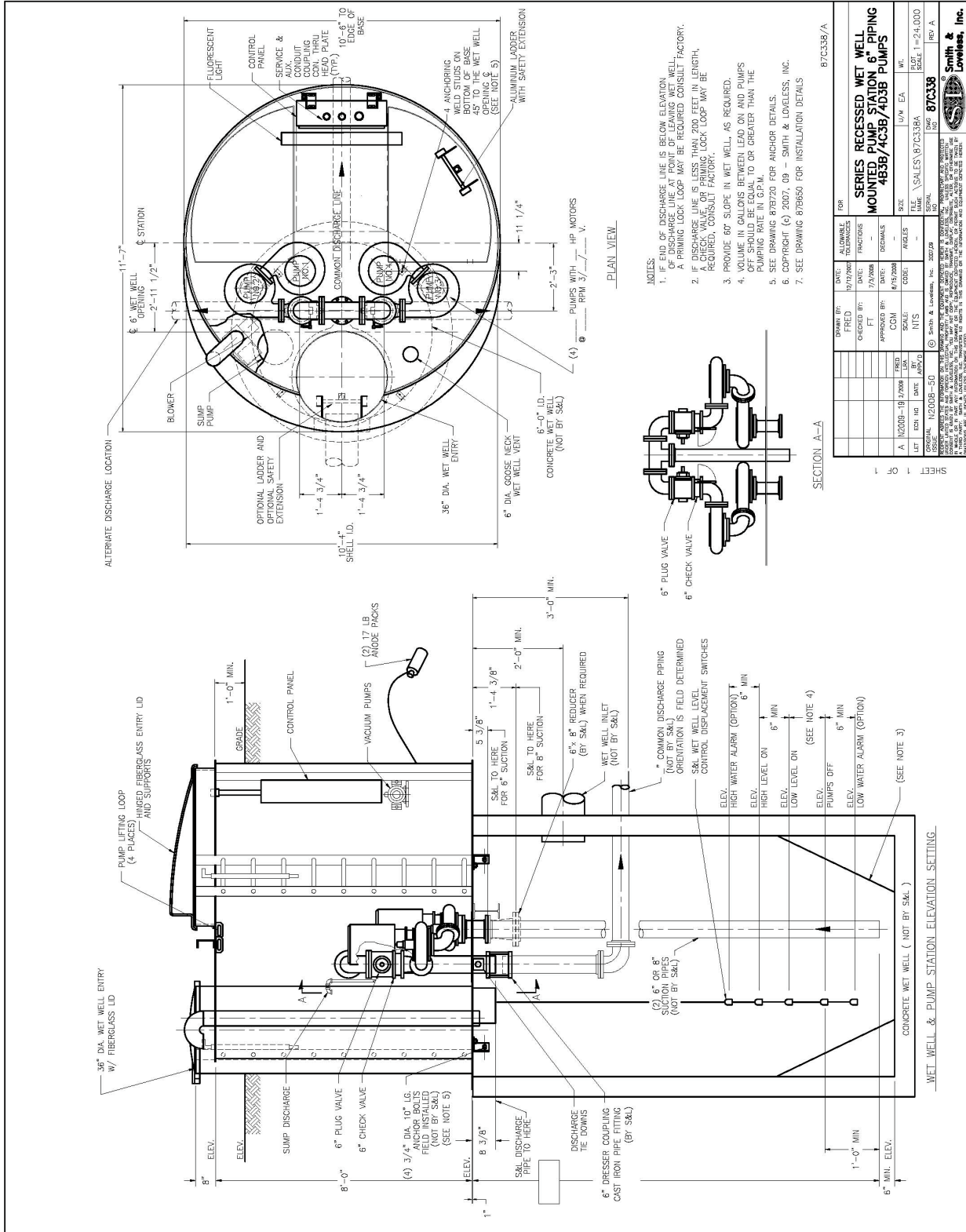

ENGINEERING DATA



Smith &
Loveless, Inc.®

14040 West Santa Fe Trail Drive
Lenexa, Kansas 66215-1284

Series Recessed Wet Well
Mounted Pump Station
Outline Drawing 87C339
6B3_ / 6C3_ / 6D3_
6" Piping
May, 2012

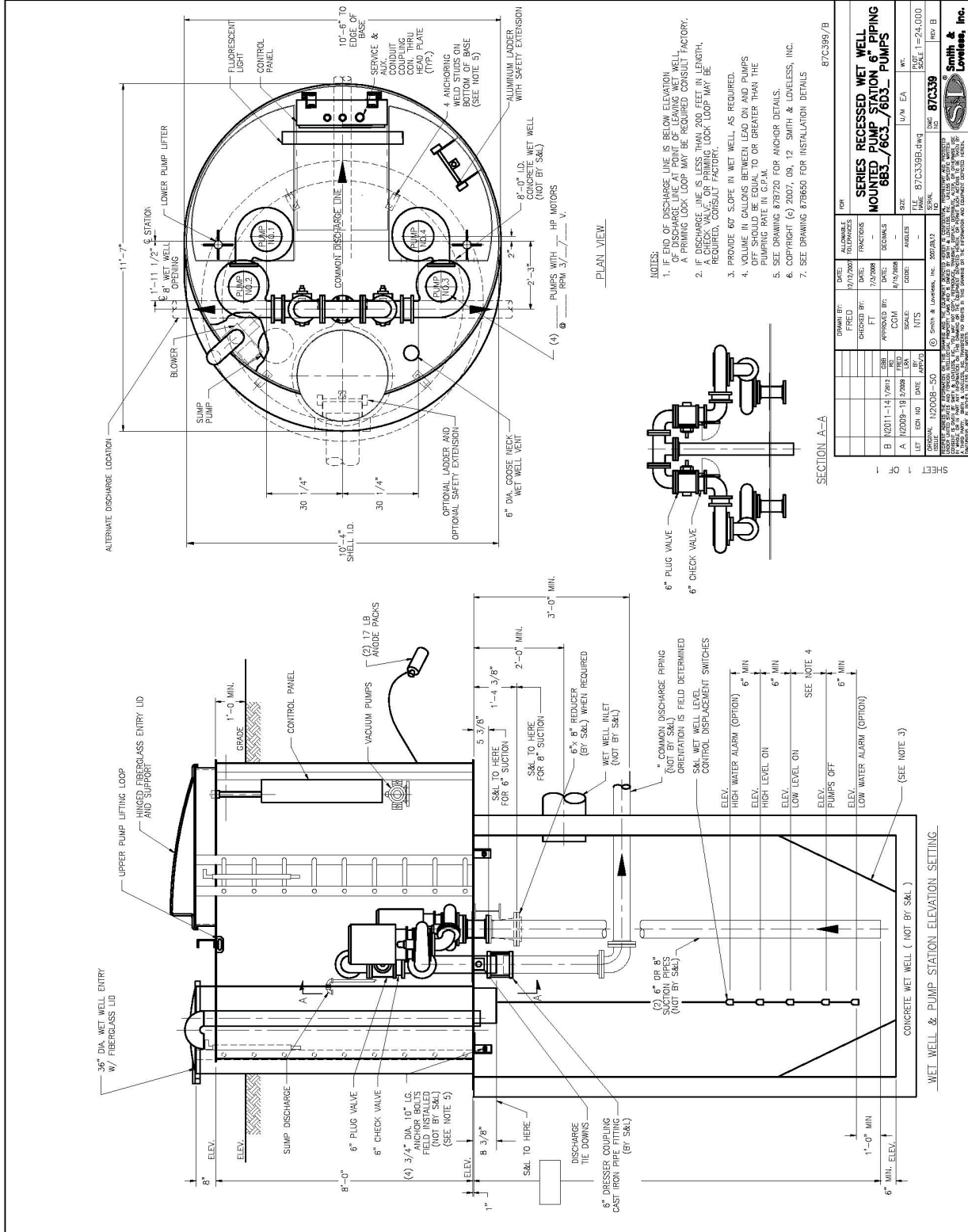

ENGINEERING DATA



Smith &
Loveless, Inc.®

14040 West Santa Fe Trail Drive
Lenexa, Kansas 66215-1284

Recessed Wet Well
Mounted Pump Station
Concrete Anchor Detail
Drawing 87B720
May, 2012

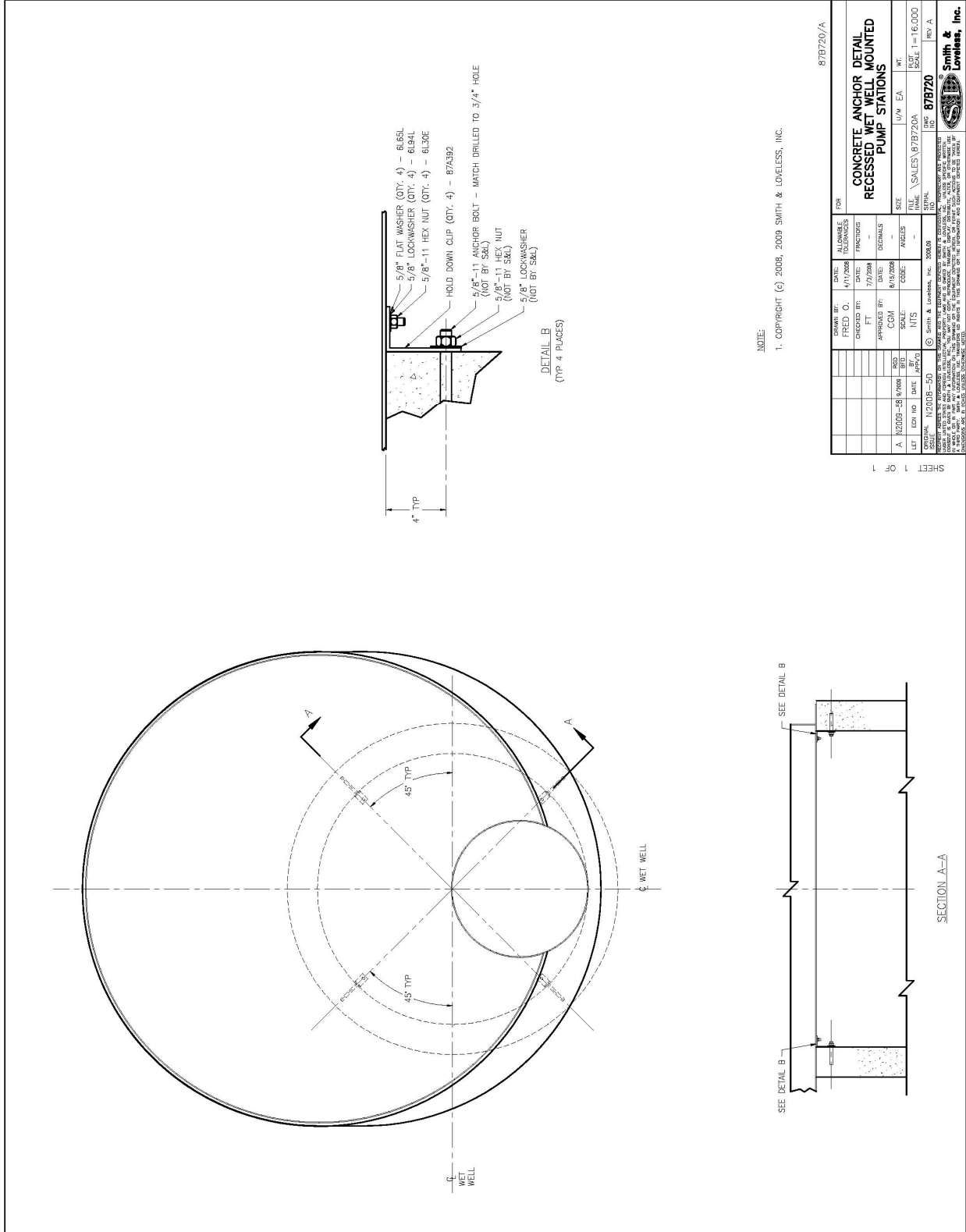

NOTE:
1. COPYRIGHT (c) 2008, 2009 SMITH & LOVELESS, INC.

DOWN BY:	DATE:	ALLOWABLE	FOR
PROD. O.	4/1/2008	CONCRETE	CONCRETE ANCHOR DETAIL
CHG. BY:	12/2/08	ANCHOR	RECESSED WET WELL MOUNTED
APPROVAL BY:	DATE:	DIGITALS	PUMP STATIONS
CCM	6/15/2008		
SCALE:	CODE:	ANGLES	U/W EA
INTS	APPROV'D		WT.
ORIGINAL: N2008-50	© Smith & Loveless, Inc. 2008/09	SERIAL	SCALE 1=16,000
LET	ENR	DATE	DATE
REV	NO	BY	REV
A	N2008-50	6/15/08	87B720
			REV A

87B720/A

SMITH & LOVELESS, INC.

ENGINEERING DATA



Smith & Loveless, Inc.®

14040 West Santa Fe Trail Drive
Lenexa, Kansas 66215-1284

Vacuum Primed Pump Stations
Installation Details
Drawing 87B650
May, 2012
Page 1

INSTALLATION DETAILS

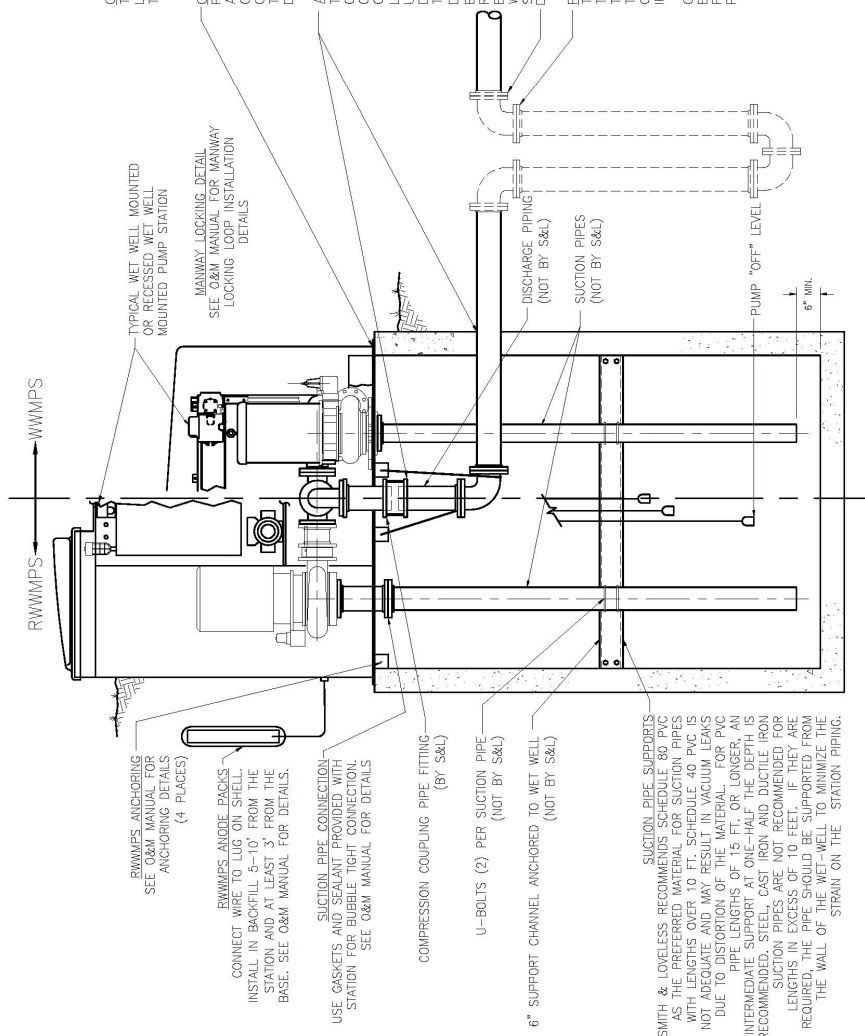

GENERAL WETWELL COMMENTS
THE WETWELL SHOULD BE INSTALLED SO THE TOP REMAINS AS LEVEL AS POSSIBLE. CONTRACTOR IS TO INSTALL SLOPES AROUND THE INTERIOR BOTTOM CORNER OF THE WETWELL.

GROUNDING STATION TO WET WELL
GROUND THE WETWELL ON TOP OF THE WET WELL. APPLY A LAYER OF NON-SHRINK OR EPOXY GROUT ON THE TOP SURFACE OF THE WET WELL. THE STATION WILL THEN BED DOWN IN THE GROUT, GIVING THE STATION FIRM SUPPORT AND REDUCING NOISE TRANSMISSIONS. THE BASE PLATE SHOULD BE LEVEL IN ALL DIRECTIONS WHEN COMPLETE.

ANCHORING/DISCHARGE CONNECTION
THE DISCHARGE IS TO BE ORIENTED IN ACCORDANCE WITH THE ENGINEER'S PLAN. GENERALLY, SMITH & LOVELESS, INC. WILL PROVIDE A COMPRESSION TYPE COUPLING TO JOIN THE FORCE MAIN TO THE STATION DISCHARGE PIPE. COMPRESSION TYPE COUPLINGS DO NOT PROVIDE PIPE END RESTRAINT. TWO LUGS ARE ALSO PROVIDED (ONE ON EITHER SIDE OF THE DISCHARGE) ON THE DISCHARGE PIPE FROM SEPARATING IN THE COUPLING. THE DISCHARGE PIPE TO THE STATION TO PREVENT SEPARATION OF THE COUPLING IN THE VERTICAL DIRECTION BY USING AN ALL-THREADED ROD, CABLE OR CHAIN (NOT SUPPLIED BY S&L). THE CONTRACTOR SHALL BE RESPONSIBLE TO PROVIDE ADEQUATE RESTRAINT AGAINST ANY HORIZONTAL THRUST DEVELOPED. THE RESTRAINT SHALL BE TIED TO THE STRUCTURE, AS THE STATION BASEPLATE IS NOT DESIGNED TO WITHSTAND HORIZONTAL THRUST FORCES. ALL DISCHARGE PIPES SHOULD BE SECURED.

DISCHARGE PIPING (NOT BY S&L)
PRIME LOCK LOOP (IF REQUIRED DUE TO DOWNHILL OR SHORT FORCE MAIN) THE PURPOSE OF THE PRIMING LOCK LOOP IS TO FORM A RETURN LOOP OR TRAP THE WATER BEHIND THE CHECK VALVE ON THE OUTSIDE OF THE WETWELL. THE LOOP MUST BE BELOW THE LOW POINT OF THE WETWELL. THIS PREVENTS THE ENTIRE CONTENTS OF A SHORT FORCE MAIN FROM RETURNING BY GRAVITY TO THE WET WELL OR BEING SIPHONED BACK INTO THE WET WELL. IF THE CHECK VALVE DOES NOT SEAT.

ON FORCE MAINS THAT RUN HORIZONTAL OR DOWN HILL FROM THE STATION, EITHER USE THE PRIME LOCK LOOP OR THE LAST FEW FEET OF THE FORCE MAIN SHOULD RUN UP HILL TO CREATE A WATER TRAP EFFECT TO PREVENT WATER DRAINING THE FORCE MAIN IN THE FORWARD DIRECTION.

NOTE:
1. COPYRIGHT (c) 2008, 2009 SMITH & LOVELESS, INC. 87B650/B

REV	DATE	DESCRIPTION
1	12/20/07	ISSUED FOR CONSTRUCTION
2	02/20/08	REVISED TO ADD DISCHARGE PIPING
3	02/20/08	REVISED TO ADD SUCTION PIPES
4	02/20/08	REVISED TO ADD PUMP OFF LEVEL
5	02/20/08	REVISED TO ADD MANWAY LOCKING DETAIL
6	02/20/08	REVISED TO ADD ANCHORING DETAILS
7	02/20/08	REVISED TO ADD DISCHARGE PIPING
8	02/20/08	REVISED TO ADD SUCTION PIPES
9	02/20/08	REVISED TO ADD PUMP OFF LEVEL
10	02/20/08	REVISED TO ADD MANWAY LOCKING DETAIL
11	02/20/08	REVISED TO ADD ANCHORING DETAILS
12	02/20/08	REVISED TO ADD DISCHARGE PIPING
13	02/20/08	REVISED TO ADD SUCTION PIPES
14	02/20/08	REVISED TO ADD PUMP OFF LEVEL
15	02/20/08	REVISED TO ADD MANWAY LOCKING DETAIL
16	02/20/08	REVISED TO ADD ANCHORING DETAILS
17	02/20/08	REVISED TO ADD DISCHARGE PIPING
18	02/20/08	REVISED TO ADD SUCTION PIPES
19	02/20/08	REVISED TO ADD PUMP OFF LEVEL
20	02/20/08	REVISED TO ADD MANWAY LOCKING DETAIL
21	02/20/08	REVISED TO ADD ANCHORING DETAILS
22	02/20/08	REVISED TO ADD DISCHARGE PIPING
23	02/20/08	REVISED TO ADD SUCTION PIPES
24	02/20/08	REVISED TO ADD PUMP OFF LEVEL
25	02/20/08	REVISED TO ADD MANWAY LOCKING DETAIL
26	02/20/08	REVISED TO ADD ANCHORING DETAILS
27	02/20/08	REVISED TO ADD DISCHARGE PIPING
28	02/20/08	REVISED TO ADD SUCTION PIPES
29	02/20/08	REVISED TO ADD PUMP OFF LEVEL
30	02/20/08	REVISED TO ADD MANWAY LOCKING DETAIL
31	02/20/08	REVISED TO ADD ANCHORING DETAILS
32	02/20/08	REVISED TO ADD DISCHARGE PIPING
33	02/20/08	REVISED TO ADD SUCTION PIPES
34	02/20/08	REVISED TO ADD PUMP OFF LEVEL
35	02/20/08	REVISED TO ADD MANWAY LOCKING DETAIL
36	02/20/08	REVISED TO ADD ANCHORING DETAILS
37	02/20/08	REVISED TO ADD DISCHARGE PIPING
38	02/20/08	REVISED TO ADD SUCTION PIPES
39	02/20/08	REVISED TO ADD PUMP OFF LEVEL
40	02/20/08	REVISED TO ADD MANWAY LOCKING DETAIL
41	02/20/08	REVISED TO ADD ANCHORING DETAILS
42	02/20/08	REVISED TO ADD DISCHARGE PIPING
43	02/20/08	REVISED TO ADD SUCTION PIPES
44	02/20/08	REVISED TO ADD PUMP OFF LEVEL
45	02/20/08	REVISED TO ADD MANWAY LOCKING DETAIL
46	02/20/08	REVISED TO ADD ANCHORING DETAILS
47	02/20/08	REVISED TO ADD DISCHARGE PIPING
48	02/20/08	REVISED TO ADD SUCTION PIPES
49	02/20/08	REVISED TO ADD PUMP OFF LEVEL
50	02/20/08	REVISED TO ADD MANWAY LOCKING DETAIL
51	02/20/08	REVISED TO ADD ANCHORING DETAILS
52	02/20/08	REVISED TO ADD DISCHARGE PIPING
53	02/20/08	REVISED TO ADD SUCTION PIPES
54	02/20/08	REVISED TO ADD PUMP OFF LEVEL
55	02/20/08	REVISED TO ADD MANWAY LOCKING DETAIL
56	02/20/08	REVISED TO ADD ANCHORING DETAILS
57	02/20/08	REVISED TO ADD DISCHARGE PIPING
58	02/20/08	REVISED TO ADD SUCTION PIPES
59	02/20/08	REVISED TO ADD PUMP OFF LEVEL
60	02/20/08	REVISED TO ADD MANWAY LOCKING DETAIL
61	02/20/08	REVISED TO ADD ANCHORING DETAILS
62	02/20/08	REVISED TO ADD DISCHARGE PIPING
63	02/20/08	REVISED TO ADD SUCTION PIPES
64	02/20/08	REVISED TO ADD PUMP OFF LEVEL
65	02/20/08	REVISED TO ADD MANWAY LOCKING DETAIL
66	02/20/08	REVISED TO ADD ANCHORING DETAILS
67	02/20/08	REVISED TO ADD DISCHARGE PIPING
68	02/20/08	REVISED TO ADD SUCTION PIPES
69	02/20/08	REVISED TO ADD PUMP OFF LEVEL
70	02/20/08	REVISED TO ADD MANWAY LOCKING DETAIL
71	02/20/08	REVISED TO ADD ANCHORING DETAILS
72	02/20/08	REVISED TO ADD DISCHARGE PIPING
73	02/20/08	REVISED TO ADD SUCTION PIPES
74	02/20/08	REVISED TO ADD PUMP OFF LEVEL
75	02/20/08	REVISED TO ADD MANWAY LOCKING DETAIL
76	02/20/08	REVISED TO ADD ANCHORING DETAILS
77	02/20/08	REVISED TO ADD DISCHARGE PIPING
78	02/20/08	REVISED TO ADD SUCTION PIPES
79	02/20/08	REVISED TO ADD PUMP OFF LEVEL
80	02/20/08	REVISED TO ADD MANWAY LOCKING DETAIL
81	02/20/08	REVISED TO ADD ANCHORING DETAILS
82	02/20/08	REVISED TO ADD DISCHARGE PIPING
83	02/20/08	REVISED TO ADD SUCTION PIPES
84	02/20/08	REVISED TO ADD PUMP OFF LEVEL
85	02/20/08	REVISED TO ADD MANWAY LOCKING DETAIL
86	02/20/08	REVISED TO ADD ANCHORING DETAILS
87	02/20/08	REVISED TO ADD DISCHARGE PIPING
88	02/20/08	REVISED TO ADD SUCTION PIPES
89	02/20/08	REVISED TO ADD PUMP OFF LEVEL
90	02/20/08	REVISED TO ADD MANWAY LOCKING DETAIL
91	02/20/08	REVISED TO ADD ANCHORING DETAILS
92	02/20/08	REVISED TO ADD DISCHARGE PIPING
93	02/20/08	REVISED TO ADD SUCTION PIPES
94	02/20/08	REVISED TO ADD PUMP OFF LEVEL
95	02/20/08	REVISED TO ADD MANWAY LOCKING DETAIL
96	02/20/08	REVISED TO ADD ANCHORING DETAILS
97	02/20/08	REVISED TO ADD DISCHARGE PIPING
98	02/20/08	REVISED TO ADD SUCTION PIPES
99	02/20/08	REVISED TO ADD PUMP OFF LEVEL
100	02/20/08	REVISED TO ADD MANWAY LOCKING DETAIL

SMITH & LOVELESS RECOMMENDS SCHEDULE 80 PVC AS THE PREFERRED MATERIAL FOR SUCTION PIPES WITH LENGTHS OVER 10 FT. SCHEDULE 40 PVC IS NOT ADEQUATE AND MAY RESULT IN VACUUM LEAKS DUE TO DISTORTION OF THE MATERIAL. FOR PVC PIPE LENGTHS OF 15 FT. OR LONGER, AN INTERMEDIATE SUPPORT AT ONE-HALF THE DEPTH IS RECOMMENDED. STEEL, CAST IRON AND DUCTILE IRON SUCTION PIPES ARE NOT RECOMMENDED FOR LENGTHS OVER 10 FT. INTERMEDIATE SUPPORTS FROM THE WALL OF THE WET-WELL TO MINIMIZE THE STRAIN ON THE STATION PIPING.

ENGINEERING DATA



Smith & Loveless, Inc.®

14040 West Santa Fe Trail Drive
Lenexa, Kansas 66215-1284

Recessed Wet Well Mounted Pump Station
Concrete Anchor Detail
Drawing 87C360
May, 2012

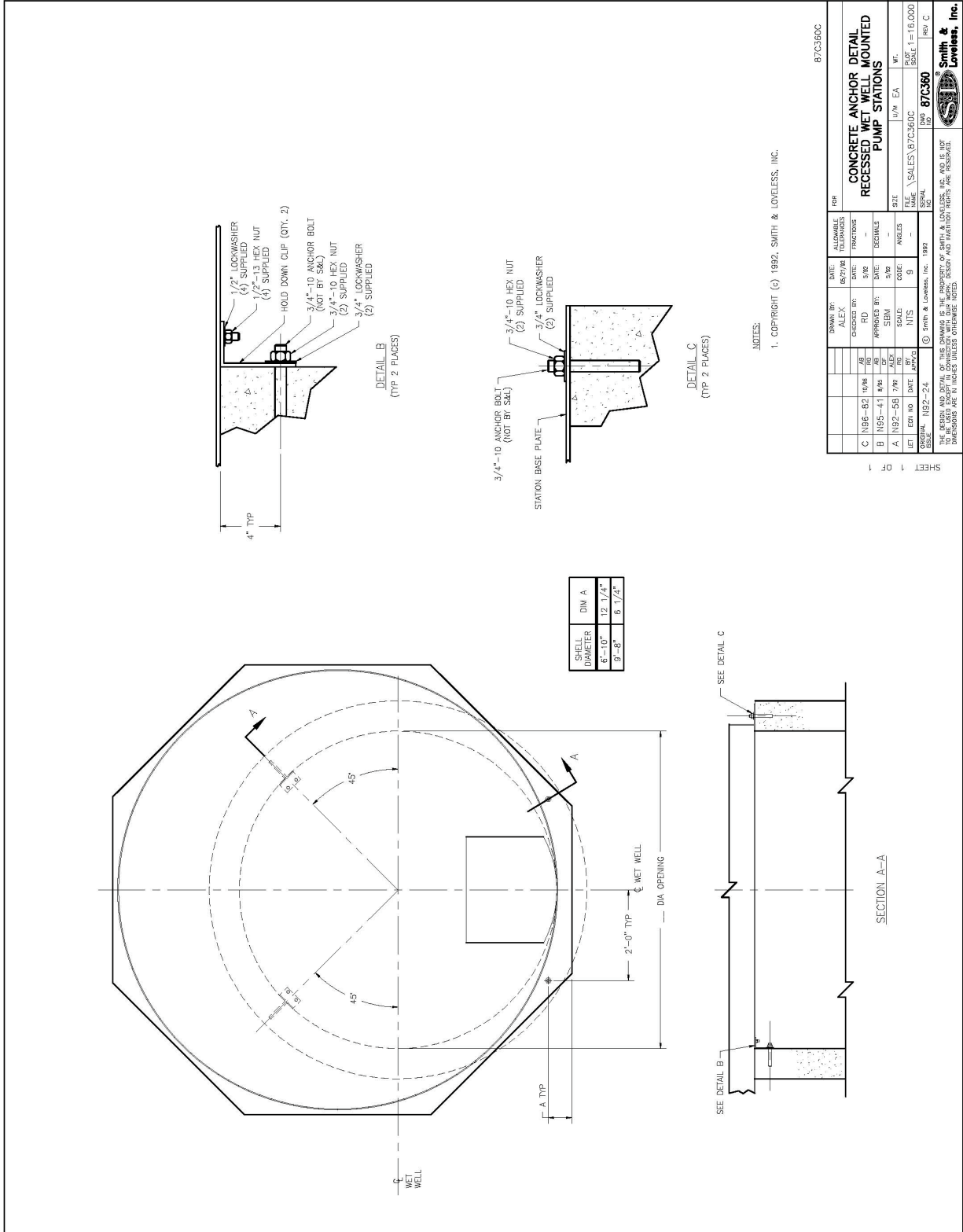

87C360C

NOTES:
1. COPYRIGHT (c) 1992, SMITH & LOVELESS, INC.

FORM		DATE		SCALE		REV	
NO.	DESCRIPTION	BY	CHKD	AS BUILT	DATE	BY	DATE
1	CONCRETE ANCHOR DETAIL RECESSED WET WELL MOUNTED PUMP STATIONS	ALEX	RD	10/16	10/16	EA	10/16
2		RD	RD	5/19	5/19	EA	5/19
3		RD	RD	10/16	10/16	EA	10/16
4		RD	RD	5/19	5/19	EA	5/19
5		RD	RD	10/16	10/16	EA	10/16
6		RD	RD	5/19	5/19	EA	5/19
7		RD	RD	10/16	10/16	EA	10/16
8		RD	RD	5/19	5/19	EA	5/19
9		RD	RD	10/16	10/16	EA	10/16
10		RD	RD	5/19	5/19	EA	5/19
11		RD	RD	10/16	10/16	EA	10/16
12		RD	RD	5/19	5/19	EA	5/19
13		RD	RD	10/16	10/16	EA	10/16
14		RD	RD	5/19	5/19	EA	5/19
15		RD	RD	10/16	10/16	EA	10/16
16		RD	RD	5/19	5/19	EA	5/19
17		RD	RD	10/16	10/16	EA	10/16
18		RD	RD	5/19	5/19	EA	5/19
19		RD	RD	10/16	10/16	EA	10/16
20		RD	RD	5/19	5/19	EA	5/19
21		RD	RD	10/16	10/16	EA	10/16
22		RD	RD	5/19	5/19	EA	5/19
23		RD	RD	10/16	10/16	EA	10/16
24		RD	RD	5/19	5/19	EA	5/19
25		RD	RD	10/16	10/16	EA	10/16
26		RD	RD	5/19	5/19	EA	5/19
27		RD	RD	10/16	10/16	EA	10/16
28		RD	RD	5/19	5/19	EA	5/19
29		RD	RD	10/16	10/16	EA	10/16
30		RD	RD	5/19	5/19	EA	5/19
31		RD	RD	10/16	10/16	EA	10/16
32		RD	RD	5/19	5/19	EA	5/19
33		RD	RD	10/16	10/16	EA	10/16
34		RD	RD	5/19	5/19	EA	5/19
35		RD	RD	10/16	10/16	EA	10/16
36		RD	RD	5/19	5/19	EA	5/19
37		RD	RD	10/16	10/16	EA	10/16
38		RD	RD	5/19	5/19	EA	5/19
39		RD	RD	10/16	10/16	EA	10/16
40		RD	RD	5/19	5/19	EA	5/19
41		RD	RD	10/16	10/16	EA	10/16
42		RD	RD	5/19	5/19	EA	5/19
43		RD	RD	10/16	10/16	EA	10/16
44		RD	RD	5/19	5/19	EA	5/19
45		RD	RD	10/16	10/16	EA	10/16
46		RD	RD	5/19	5/19	EA	5/19
47		RD	RD	10/16	10/16	EA	10/16
48		RD	RD	5/19	5/19	EA	5/19
49		RD	RD	10/16	10/16	EA	10/16
50		RD	RD	5/19	5/19	EA	5/19

SMITH & LOVELESS, INC.

ENGINEERING DATA



Smith & Loveless, Inc.®

14040 West Santa Fe Trail Drive
Lenexa, Kansas 66215-1284

3-Pump Recessed Wet Well
Mounted Pump Station
Outline Drawing 87B718
May, 2012

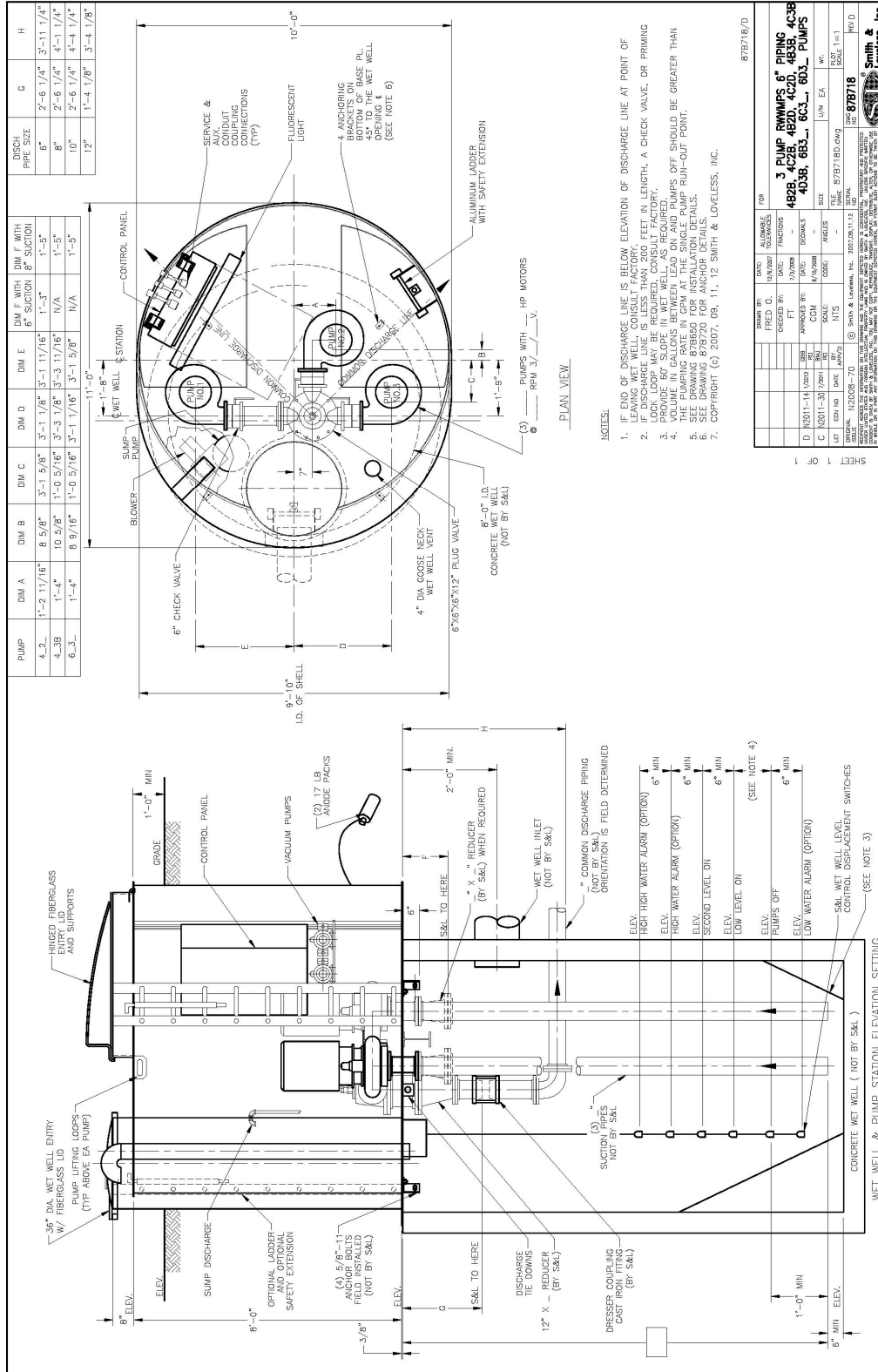

ENGINEERING DATA



Smith & Loveless, Inc.®

14040 West Santa Fe Trail Drive
Lenexa, Kansas 66215-1284

Recessed Wet Well Mounted Pump Station
Concrete Anchor Detail
Drawing 87B720
May, 2012

